



SERVICE MANUAL

SERIES 90 SINGLE PRICE / SIID E-MODEL VENDERS

**Beginning Serial #0001-6368DU
October 1996**

**Operation Manual
Set-Up
Troubleshooting**

January 20, 1998



Dixie-Narco

Dixie-Narco Blvd.
P.O. Drawer 719
Williston, South Carolina 29853

Ph: (800) 688-9090 Ph: (803) 266-5000 Fax: (803) 266-5150

803,902,760.01

TABLE OF CONTENTS

General Information.....	3
Installation & Set-Up.....	4 - 11
Electrical Parts and Their Function	12 - 20
Product Shimming	21 - 23
Adjustments: Cams/Rear Spacers.....	24 - 27
Vend Cycle / Sequence of Operation	28 - 32
Single Price	28 - 29
SIID Controller Style Coin Mech Escrow to Price (PR).....	30
SIID Controller Style Coin Mech Escrow to Select / Last Bill Escrow (E-S1).....	31
SIID Controller style Coin Mech Escrow to Select / No bill Escrow (E-S4)	32
Troubleshooting.....	33 - 62
Single Price.....	33 - 38
SIID Vending.....	39 - 40
SIID Coin / Currency.....	40 - 41
SIID Sold Out	42
SIID Select Panel / Display	42 - 44
SIID Troubleshooting Flow Charts	45 - 61
Select Panel -"1-1-1-1" Scrolls	45
Select Panel – Cannot Enter Diagnostics	46
Select Panel – One or more switches not functional	47
Sold Out Switches – Not recognizing sold-out	48
USA Low Level Validator – Will not take note or display	49 - 50
Mars VFM1 or VFM3 Validator – Will not take note or display	51
High Level Validator – Will not take note or display	52 - 53
Mdb Coin Mech/Validators – Will not take note or display	54 - 55
Mdb Coin Mech – Will not take coins	56 - 57
Micro Mech (MC 5000).....	58 - 59
Maka (MC5000) Mech – Will not take coins.....	60 - 61
Refrigeration Parts and Functions	62 - 66
Refrigeration Cycle.....	67
Refrigeration Troubleshooting	68 - 72
Product Hot – Compressor will not run.....	68
Product Hot – Compressor starts but will not keep running	69
Product Hot – Miscellaneous.....	69
Product Cold But Not Cold Enough – Compressor runs but won't cool product	70
Product Too Cold or Frozen – Compressor runs too long or continuously	71
Noisy Refrigeration Unit	71
Excessive Condensate.....	72

GENERAL INFORMATION

VENDER SAFETY PRECAUTIONS

Please read this manual in its entirety. This service information is intended to be used by a qualified service technician, who is familiar with proper and safe procedures to be followed when repairing, replacing or adjusting any Dixie-Narco vender components. All repairs should be performed by a qualified service technician who is equipped with the proper tools and replacement components using genuine Dixie-Narco factory parts.

Repairs and/or servicing attempted by untrained persons can result in hazards developing due to improper assembly or adjustments while performing such repairs. Persons not having the proper background may subject themselves to the risk of injury or electrical shock which can be serious or even fatal.

PRODUCT IDENTIFICATION

The age of Dixie-Narco products is determined by the date code incorporated in the serial number.

The vender serial number takes the form xxxx-yyyzz. The first 4 digits (xxxx) identify the specific vender. The next 4 digits (yyyy) identify the manufacturing run that the vender was built in. The last two alpha characters (zz) identify the quarter and the year the vender was built. The first alpha character identifies the quarter:

- A = 1st quarter
- B = 2nd quarter
- C = 3rd quarter
- D = 4th quarter

The second alpha-character identifies the year:

- U = 1996
- V = 1997
- W = 1998
- X = 1999
- Y = 2000
- Z = 2001

INSTALLATION - SERIES 90 CAN & BOTTLE VENDER

INSTALLATION & SET-UP

RECEIVING INSPECTION

Upon receipt, inspect the vender for shipping damage. If there is any damage, have the driver note the damage on the Bill of Lading and notify Dixie-Narco. Although the terms of the vender sale require that the consignee originate shipping damage claims, Dixie-Narco will gladly help if you must file a claim.

UNPACKING THE VENDER

Remove the stretch wrap and top covers from the vender. If flavor cards were shipped with the vender, they will be in an envelope affixed to the back of a vender in the shipment or in the cash box.

NOTE: DO NOT STORE THE VENDER OUTSIDE WITH STRETCH WRAP ON. THIS COULD CAUSE THE STRETCH WRAP TO BOND TO THE VENDER'S SURFACE, WHICH COULD DAMAGE THE FINISH.

Remove the shipping boards from the bottom of the vender. The shipping boards are attached by the leveling legs. Remove the shipping boards by **unscrewing** the leveling legs. A 1½" "socket-type" wrench should be used on the bottom of the leveling legs. Be sure to replace the legs after removing the shipping boards.

To open the vender, locate the door lock keys which are secured inside the coin return cup. After unlocking the door, rotate the "T"-handle counter-clockwise until the door can be opened. Once inside, check the coin box on the door for any additional parts, pricing labels, or information concerning factory equipped accessories. Check the "T"-handle for proper alignment and locking functions. Check the lamps for proper installation.

WARNING: ENSURE THAT POWER IS DISCONNECTED FROM THE VENDER OR THAT THE POWER INTERRUPT SWITCH (IF PROVIDED) IS NOT DEFEATED BEFORE INSPECTING OR REPLACING THE LAMPS. FAILURE TO COMPLY WITH THESE INSTRUCTIONS MAY SUBJECT THE USER TO THE RISK OF INJURY OR ELECTRICAL SHOCK, WHICH CAN BE SERIOUS OR FATAL.



ELECTRIC POWER NEEDED

Refer to the vender serial number plate to determine the proper voltage and frequency the machine requires (domestically this requirement is 115 volt, 60 hertz). Domestic venders will operate at +/- 10% of the specified voltage. For domestic models this is between 103 volts and 127 volts. The cabinet serial plate also indicates the amperage of the vender. Single phase, alternating current is required. The vender must be plugged in its own properly rated circuit with its own circuit protection (fuse/circuit breaker).

DO NOT USE AN EXTENSION CORD.

GROUND THE VENDER

The vender is equipped with a three wire power supply cord and **MUST** be plugged into a properly grounded outlet.

DO NOT REMOVE THE GROUND PIN OR IN ANY WAY BYPASS THE GROUNDING OF THE VENDER. If the outlet will not accept the power cord plug, contact an electrician to install a proper AC outlet.



WARNING: Failure to comply with these instructions may subject the user to the risk of injury or electrical shock which can be serious or fatal.

COIN CHANGERS

The Series 90 Vender must have a coin changer installed. Most styles can have a bill acceptor installed. If the coin changer and other accessories are not factory installed, refer to the instructions received from the manufacturer of the coin changer and other accessories for proper set-up and installation.

SINGLE PRICE VENDERS

The following single price coin changers will work properly with the Series 90 Single Price Vender:

MARS Electronics Int.	Coin Acceptors, Inc.	Crane Int'l. Currency	CONLUX-USA
TRC 6200 MC 5802	3340-S S75-9400B-977	525E	US-111A-1
TRC 6200C MC 5800	9340-S S75-9800B-907	525C	US-111A-1D
TRC 6800 MC 5800 DH	9360-S	525EC	USA-121 A-OC
TRC 6800 H	9370-S	500	
TRC 6800 C	S300E9240	510	
TRC 6800 HC			

SIID VENDERS

The following coin changers will work with the Series 90 SIID vender:

Micro-Mech/Controller 110V (12 pin) Changers (domestic)
Mars TRC 6000
Coinco 9300L
Maka USPX001
Micro-Mech Controller 24V (15 pin) Changers (domestic)

CAUTION: DO NOT USE 24V(12 PIN) CHANGERS. USE OF 24V (12 PIN) CHANGERS WILL CAUSE DAMAGE TO ELECTRONICS PACKAGE AND CHANGER.

Multi-Drop Coin Mech (domestic)
Coinco 9302GX
Mars TRC 6510
L+ Coin Mech (International)

INSTALLING A COIN CHANGER

Hang the coin changer on its mounting plate and secure it by tightening the three securing screws. Plug the coin changer into the appropriate changer socket.

CAUTION: ON SIID VENDERS THE COIN CHANGER MUST BE PLUGGED IN WITH THE POWER REMOVED FROM THE DOOR OR THE COIN CHANGER MAY NOT POWER ON PROPERLY. IF A BILL ACCEPTOR IS BEING USED, THE BILL ACCEPTOR MUST BE INTERFACED PROPERLY TO THE COIN CHANGER OR CONTROL BOARD.

After restoring power, manually load the coin changer coin tubes with at least ten coins each. In SIID venders, follow the program instructions and program each selection for its own vend price. A price of \$0.00 is free vend. After the pricing is set, return the vender to its operate mode either by closing the door or pulling the door closed switch out. In single price venders, follow the instructions for the coin changer provided by the manufacturer. "Prime" the coin changer by making a correct change transaction.

BILL ACCEPTORS

If a bill acceptor is not factory installed, the proper interface harness must be ordered. Also, refer to the instructions provided by the coin changer and bill acceptor manufacturers.

BILL ACCEPTOR INTERFACE HARNESSES - SINGLE PRICE

See instructions provided by the bill acceptor manufacturer.

T-Adapter (for use with hi level Note Acceptors) – 805,501,14x.x1

BILL ACCEPTOR INTERFACE HARNESSES - SIID

Acceptor	Pepsi-Cola & Other Venders	Coca-Cola Venders
Ardac USA	804,909,72x.x1 (lo level)	not applicable
Mars VFM-1, VFM-3, & VN2000 Series	*804,912,59x.x1 (lo level)	not applicable
Maka NB-10L-200	804,909,76x.x1 (hi level)	not applicable
Coinco/Rowe CBA-2 \$1 Only	*804,909,75x.x1 (hi level)	not applicable
Row CBA-2 \$1 & \$5 (UBA-2)	*804,909,75x.x1 (hi level)	not applicable
Mars VFM-1 & VFM-3	804,909,74x.x1 (hi level)	not applicable
Coinco BA30	*804,909,79x.x1 (hi level)	not applicable
Coinco BA30 (Mdb)	804,912,61x.x1 (Mdb)	804,912,61x.x1 (Mdb)
Mars VN2000 Series (Mdb)	*multidrop bus	*multidrop bus

*also requires parts from acceptor manufacturer.

Note: Bill acceptors will be inhibited anytime the door interlock switch is in the center position (service mode enable), even if service mode time-out has occurred, restoring the vender to normal operation.

OTHER ACCESSORIES

SIID venders are capable of interfacing to Debit Card and Data Recording systems. Presently Dixie-Narco has tested only a few such accessories. If such accessories are to be used, check with either Dixie-Narco or the accessory manufacturer about physical and electrical compatibility before attempting to interface such accessories to the SIID vender.

PLACING THE VENDER ON LOCATION

CAUTION: DO NOT TRANSPORT THE VENDER TO OR FROM THE LOCATION WHEN IT IS LOADED WITH PRODUCT; DAMAGE TO THE VENDER MAY RESULT.

The vender must be located on a solid, flat, and level surface.

The vender must be positioned close enough to an electrical outlet that an extension cord is ~~not~~ required. If securing the vender to the floor or wall is required, call the Dixie-Narco Factory Service Department or your Dixie-Narco Representative for suggestions.

LEVEL THE VENDER

Level the vender. When the vender is level, the door can be opened to any position and it will not move by itself. Open the door to several different positions before deciding that the vender is level. A carpenter's level will help to verify that the machine is level. Make sure that all of the leveling legs are in contact with the floor. If you cannot level the vender, select another location. Do not place any objects under the machine.

DANGER: THE VENDER MUST BE PROPERLY LOCATED AND LEVELED TO MINIMIZE THE RISK OF INJURY OR DEATH FROM TIPPING IN THE EVENT OF MISUSE OR VANDALISM.

SPACE THE VENDER

Do not block the rear of the vender. Keep the vender 4 inches (10 cm) from the wall to insure adequate air flow to the condenser and compressor. At the front of the vender, make sure that nothing obstructs the air intake at the bottom of the main door. At the rear of the vender, make sure that nothing obstructs the air exhaust at the bottom of the cabinet.

INSTALLING FLAVOR CARDS

The flavor cards may be inserted one of two ways: 1) in the selection buttons, or 2) in the flavor card carrier.

- 1.) Swing the coin changer mounting plate away from the outer door exposing the back of the select buttons. The flavor cards are inserted in the back of the selection buttons from either side. Ensure the flavor cards are placed in the select buttons that correspond to the column in which the product is loaded.
- 2.) Swing the coin changer mounting plate away from the outer door, exposing the back of the select panel. Remove the flavor card carrier. Ensure the flavor cards are placed in the select button flavor card carrier position that corresponds to the column in which the product is loaded. Install the flavor card carrier back into position.

CLEANING THE VENDER



DO NOT USE A WATER JET OR NOZZLE TO CLEAN THE VENDER.

SIGN FACE

The polycarbonate sign face requires proper cleaning to prolong the service life of this item. It is recommended that you periodically clean the sign face as follows:

1. Rinse the sign with a soft cloth or sponge soaked in warm water.
2. If necessary, use a mild soap to loosen any dirt or grime. To prevent damage, **DO NOT SCRUB** or use a brush or squeegee, as some signs have a clear ultraviolet resistant coating to prevent yellowing.
3. Repeat the above steps as necessary, then dry using a soft cloth to prevent spotting.

CABINET

- * Wash the cabinet with a good detergent or soap mixed in warm water.
- * Wax the vender often with a good grade of automobile wax.
- * Any corrosion inside the vender should be removed with fine steel wool and the area should be painted with aluminum paint.
- Repair any scratches on painted surfaces to prevent corrosion.



WARNING: THE COMPRESSOR ELECTRICAL CIRCUIT IS ALWAYS LIVE WHEN THE PLUG IS CONNECTED TO AN ELECTRICAL OUTLET.

REFRIGERATION CONDENSER

- * Check the condenser periodically for dirt or lint build up.
- * Remove the build up with a brush or vacuum, or blow the dirt out of the condenser with compressed air and approved safety nozzle.
- * Ensure nothing obstructs air intake at the bottom of the main door.
- * Ensure nothing obstructs air exhaust at the rear of the cabinet.

COIN ACCEPTOR

- * Follow the Coin Acceptor Manufacturer's instructions.

LUBRICATING THE VENDER

The vender refrigeration system does not require any field lubrication. The hermetic refrigeration system and fan motors are manufactured with lifetime lubrication.

<i>TIME</i>	<i>COMPONENT</i>	<i>LUBRICANT EXAMPLE</i>
Every 6 Months (or as needed)	Main Door 1. Lock Bolt & Nut Retainer 2. Hinge Pivot Points	Mechanics Friend
	Inner Door 1. Hinge Pivot Points	Mechanics Friend
Every Year (or as needed)	Inner Door 1. Door Gasket	Petroleum Jelly

TEMPERATURE CONTROL ADJUSTMENTS

Adjustment #1 - Temperature Adjustment

Turn the adjustment pointer clockwise for colder product and counter-clockwise for warmer product.

Adjustment #2 - Altitude Adjustment



WARNING:

DISCONNECT POWER TO THE VENDING MACHINE BEFORE PROCEEDING WITH THIS ADJUSTMENT.

The control is factory set for an altitude of 152 M (500 ft.). For higher altitudes, adjust the inside range screws to prevent freeze-up of the product. Adjust the inside range screws as follows.

ALTITUDE		EATON 9531-N375 for 501E/600E EATON 9531-N387 for 276E
Meters	Feet	Turn both screws counter clockwise
610	2,000	1/8 Turn
1219	4,000	1/4 Turn
1829	6,000	1/2 Turn
2438	8,000	5/8 Turn

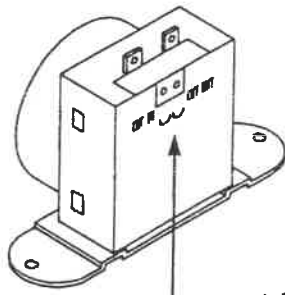

Adjustment #2

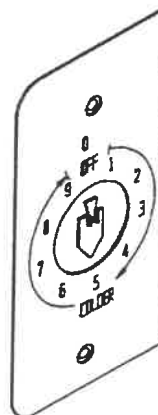
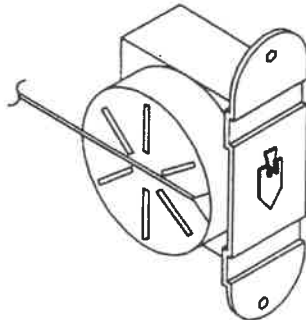

Adjustment #1

CHECK IT OUT

WHAT TO DO	WHAT SHOULD HAPPEN
Plug the power cord in.	The compressor, condenser fan, and evaporator fan run, "Use Correct Change" window lights and "Sold Out" lamps light. The fluorescent tubes light.
Load at least six beverages in each column.	Sold out lights go off in single price venders and sold-out message goes off in SIID venders.
Close the vender door, put in correct change, and push a select button.	Product is dispensed and delivered.
If a dollar bill validator is used: Load the changer with at least 10 quarters, 10 dimes, and 10 nickels. Prime the coin changer, insert \$1 bill in the validator.	Correct change is paid back.
Push a select button.	Product is dispensed and delivered.
Once the vender is placed on location, load the changer money tubes. Fully load the vender with product and allow it to run overnight.	Return to the vender the next day and vend a product from each column. A cold product is dispensed from each column and correct change is returned. The first product vended has a temperature of 0 ⁰ C (32 ⁰ F) to 1 ⁰ C (34 ⁰ F).

ELECTRICAL PARTS AND FUNCTIONS

CORRECT CHANGE LAMP

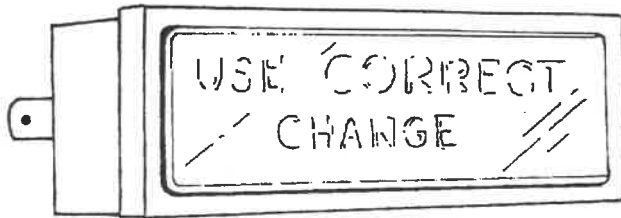

Correct Change Lamp
904,700,18x.x1
Single Price (English)

OR



Correct Change Lamp
804,700,54x.x1
Single Price (125 VAC)

The Correct Change Lamp is mounted in the Coin Insert Casting.

The Correct Change Lamp is controlled by the Coin Changer and is "OFF" when coins are in the tubes of the Coin Changer.

SELECT SWITCH

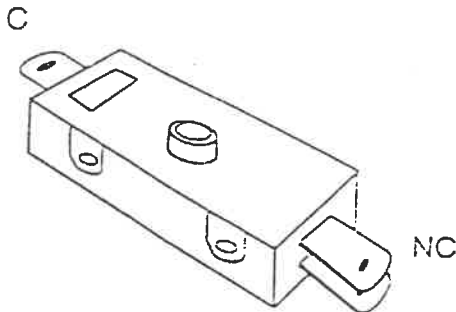

Select Switch
804,100,51x.x1 - Single Price
804,100,76x.x1 - SIID

OR

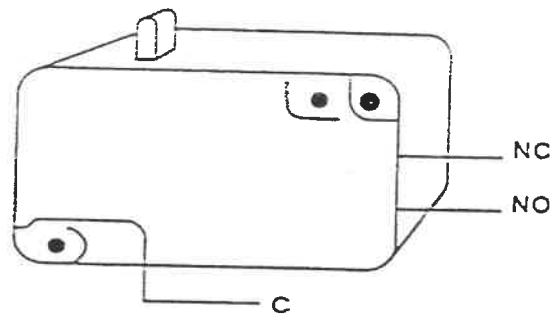

Select Switch
804,100,71x.x1 - Single Price
804,100,74x.x1 - SIID

The Select Switch is located in the Select Panel behind the press button and is secured with two (2) screws.

SINGLE PRICE VENDERS

The normally open contact of the Select Switch is in the Sold-Out Lamp and Vend Motor Coil Circuits. When a Select Button is pushed, the normally open contact closes and completes the Sold Out Lamp Circuit and the Vend Motor Coil Circuit.

The normally closed contact of the Select Switch is in the Select Panel Circuit.

SIID VENDERS

The normally closed contact of the Select Switch is in the SIID Control Board and Vend Motor Coil Circuits. This normally closed contact opens and the SIID Control board Circuit completes the Vend Motor Coil Circuit.

The normally open contact of the select switch has no function.

SOLD OUT SWITCHES (2 IN A CLUSTER)

The Sold Out Switch is located on the Front Mechanism Plate under the Vend Motor Cover.

The Sold Out Switches are the "snap in" type. To install, place the switch in position over the opening, push in and at the same time, slide to the right.

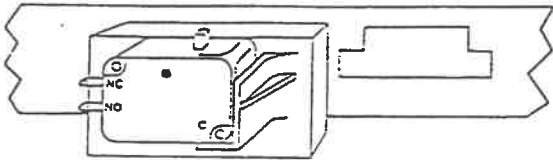

Sold Out Switch Pak
804,100,68x.x1 -Single Price
804,100,75x.x01 - SIID

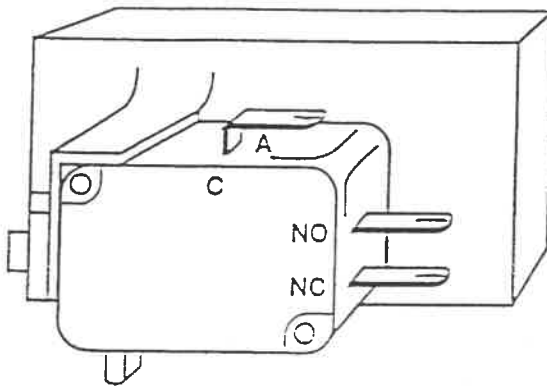
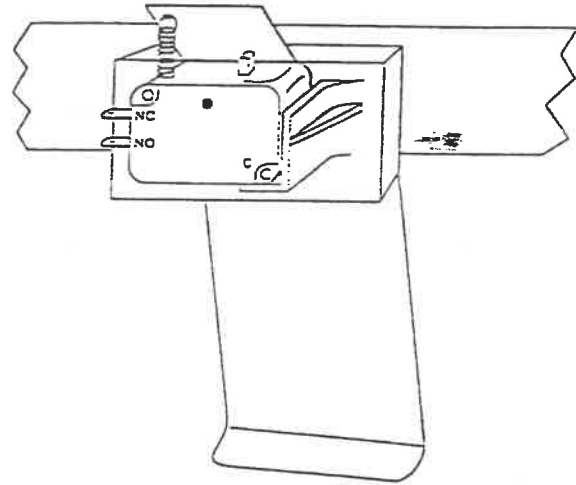

SINGLE PRICE VENDERS

A) **Front Sold Out Switch (one for each column)**

The normally closed contact of the front Sold Out Switch is in the Vend Relay Coil Circuit and the Coin Changer Inhibit Circuit. This normally closed contact (kept closed by can or bottle) is in parallel with all the other normally closed contacts of the Front Sold Out Switches and when all are open, the coin changer will not accept coins.

The normally opened contact of the front Sold Out Switch has no function.

B) **Vend Sold Out Switch (one for each vending circuit)**

The normally closed contact of the Vend Sold Out Switch is in the Vend Motor Circuit. This normally closed contact (held closed by can or bottle) stays closed in the vend motor circuit so the Vend Motor Circuit can be completed.

The normally open contact of the Vend Sold Out Switch is in the Sold Out Lamp circuit (kept open by a can or bottle). When not kept open by a can or bottle, the normally open contact closes and completes the Sold Out Lamp Circuit.

SIID VENDERS

A) **Vend Sold-Out Switch (one for each vending circuit)**

The normally closed contact of the front Sold Out Switch has no function. The normally open contact of the Sold-Out Switch is in the Sold-Out Circuit (kept open by a can or bottle). When not kept open by a can or a bottle, the normally open contact closes and completes the Sold-Out Message Circuit via the SIID Control Board.

SOLD OUT LAMPS - (SINGLE PRICE VENDERS ONLY)

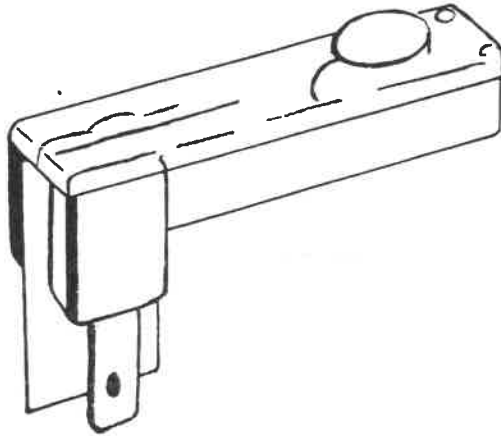

Sold Out Lamp
804,700,51x.x1 - Pepsi, Generic
804,700,54x.x1 - Coke
804,700,63x.x1 - Dr. Pepper V4

The Sold Out Lamp (one for each vending circuit) is secured to the back of the select button in the Selector Panel. The Sold Out Lamp is turned on by the closing of the normally open contact of the Vend Sold Out Switch.

COIN VEND SWITCH - (SINGLE PRICE VENDERS ONLY) (Coin Changer)

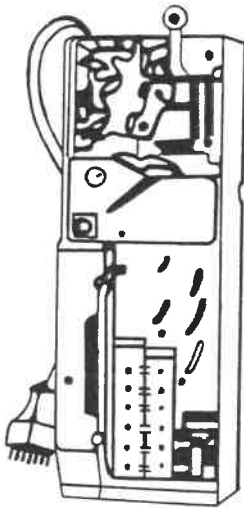

Coin Changer

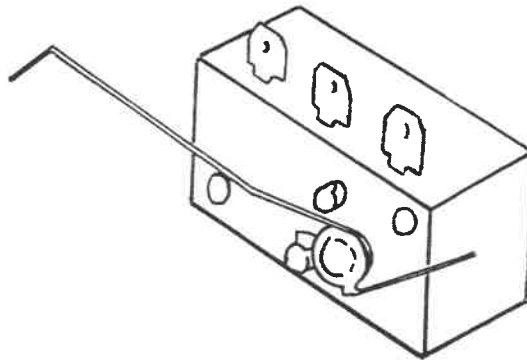

Coin Vend Switch
(Used in mechanical coin mechs)

The Coin Vend Switch is located below the slug rejector and is fastened to the coin changer housing with two (2) screws and nuts.

The normally open contact of the Coin Vend Switch is in the vend relay coil and the coin changer magnet circuits. This normally open contact closes and completes the vend relay circuits.

The normally closed contact of the Coin Vend Switch is in the Vend Motor Coil Circuits. This normally closed contact closes in the Vend Motor Coil Circuits to set up these circuits so that a selection can be made.

VEND MOTOR

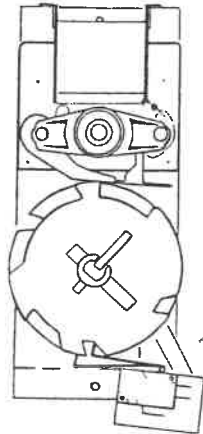

For Narrow Column

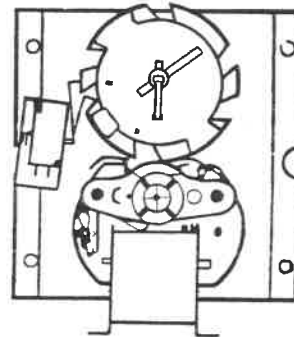

For Wide Column

The Vend Motor (one for each vending stack) is mounted on a bracket on the front of the Front Mechanism Plate.

SINGLE PRICE VENDER

The Vend Motor is in the Vend Motor Coil Circuit. The Vend Motor runs when a select button is pushed. The normally open contact of the select switch closes and completes the Vend Motor Coil Circuit. The Vend Motor continues to run through the normally open contact (closed by the Vend Motor Cam) of the Vend Motor Switch. The Vend Motor stops when the Vend Motor Switch arm drops off the high side of the Vend Motor Cam.

SIID VENDER

The vend motor is in the Vend Motor Coil Circuit. The Vend Motor runs when a normally closed contact of the Select Switch pushed, opens and signals the SIID Controller Board to run the motor. The Vend Motor continues to run via the SIID Controller Board while the Vend Motor Switch is on the high side of the cam. The Vend Motor stops when the Vend Motor Switch Arm drops off the high side of the Vend Motor Cam, and the normally closed contact of the Vend Motor Switch closes, signaling the SIID Controller Board to stop power to the Vend Motor Coil Circuit.

VEND MOTOR SWITCH

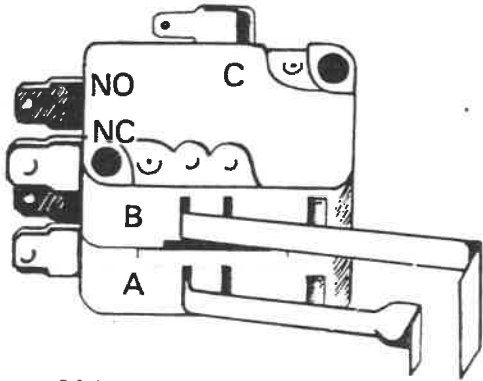

804,100,69x.x1 - Single Price

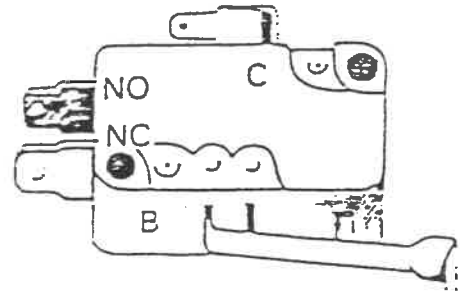

804,100,73x.x1 - SIID

SINGLE PRICE VENDER

A. Vend Motor Switch

The Vend Motor and the By-Pass Switches are secured together and referred to as a Cluster Switch. The Cluster Switch, one (1) for each circuit, is located on the Vend Motor Assembly and secured by two (2) screws.

The normally open contact of the Vend Motor Switch (A) is in the Vend Motor Coil Circuit. This contact closes to keep the Vend Motor running and at the same time lights the Sold Out Light, until the arm of the Vend Motor Switch drops into the cam notch and the Vend Motor stops.

The normally closed contact of the Vend Motor Switch has no function.

B. By-Pass Switch

The By-Pass/Vend Motor Switches are together and do not come apart. The By-Pass Switch, one (1) for each circuit, is located on the Vend Motor Assembly secured by two (2) screws. This switch is a by-pass around the Vend Motor Switch to keep the Coin Changer Inhibit Circuit closed if the Vend Motor stops or is stopped when the arm of the Vend Motor Switch is top side of the vending cam, i.e. all other vending circuits are operative.

The normally open contact of the By-Pass Switch, (held closed by the vending cam), is in the Coin Changer Inhibit Circuit. Shortly after the beginning of the vending cycle, the arm of the switch (worked by the vending cam) drops into the cam notch and this normally open contact opens in the Coin Changer Circuit.

When the arm of the switch reaches the top side of the cam, the normally open contact closes and restores power to the changer circuit. The normally open contact remains closed at the end of the vending cycle.

The normally closed contact of the By-Pass Switch is in the Coin Changer Circuit. This normally closed contact opens in the Coin Changer Circuit. The normally closed of the By-Pass Switch is also in the Vend Motor Coil Circuit. The normally closed contact closes in the Vend Motor Coil Circuit to keep the Vend Motor running until the normally open contact of the vend motor switch closes to keep the Vend Motor running.

HOW THE VEND/BY-PASS SWITCHES WORK

SINGLE PRICE VENDERS

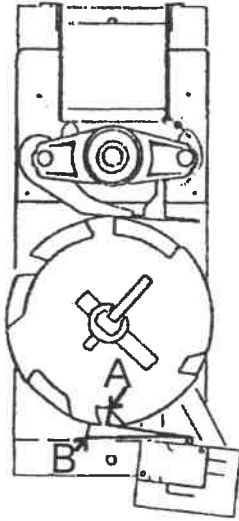

For Narrow Column
Figure 1

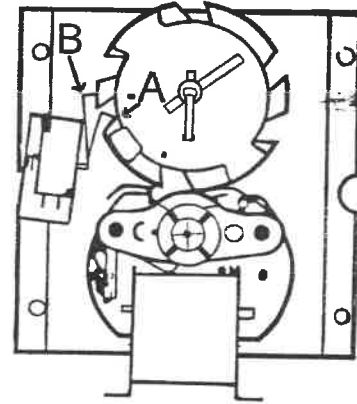

For Wide Column
Figure 2

1. The Vend Motor and Vend Motor Switches are shown in the stand-by position. (See figure 1 and figure 2)
The arm of the Vend Motor Switch A is in the cam notch (low cam).
The arm of the By-Pass Switch B is on top of the cam (high cam).
2.
 - a. Set up a credit.
 - b. Make a selection.
(Pushing a select switch causes the vend motor to run and the arm of the by-pass switch drops in the cam notch and breaks the circuit to the vend relay coil - cancels credit.)
 - c. The Vend Motor continues to run through the notch.
 - d. The arm of the Vend Motor switch reaches high cam causing the vend motor to continue to run.
 - e. A fraction of a second later, the By-Pass switch arm reaches high cam and forms a by-pass around the Vend Motor Switch. If a jam occurs, all other selections will work.
 - f. The Vend Motor continues to run to the stand-by position.

SIID VENDER

A. Vend Motor Switch

The vend motor switch, one (1) for each circuit, is located on the Vend Motor Assembly and secured by two screws.

The normally closed contact of the Vend Motor Switch is in the Vend Motor Coil Circuit. This normally closed contact opens in the Vend Motor Coil Circuit to keep the Vend Motor running via the SIID Controller Board, until the arm of the Vend Motor Switch drops in the cam notch and the vend motor stops. The normally open contact of the vend motor switch has no function.

VEND RELAY (SINGLE PRICE ONLY)

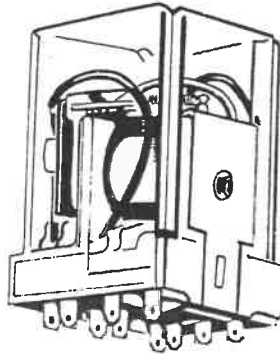

804,200,17x.x1

VEND RELAY SWITCH NO. 1 Normally Closed (the Normally Open contact is not used)

The normally closed contact of the Vend Relay Switch No. 1 is the Coin Changer Inhibit Circuit. When this normally closed contact opens, the Coin Changer is inhibited.

VEND RELAY SWITCH NO. 2 Normally Open (the Normally Closed contact is not used)

The normally open contact of the Vend Relay Switch No. 2 is in each of the Vend Motor Coil Circuits. This contact closes in the Select Panel and provides power to the select switches circuit so that a selection can be made.

VEND RELAY SWITCH NO. 3 Normally Open (the Normally Closed contact is not used)

The normally opened contact of the Vend Relay Switch No. 3 is in the Vend Relay Coil Circuit. This normally open contact closes and keeps the Vend Relay Coil energized.

SEQUENCE RELAY (Single Price, Not On All Venders)

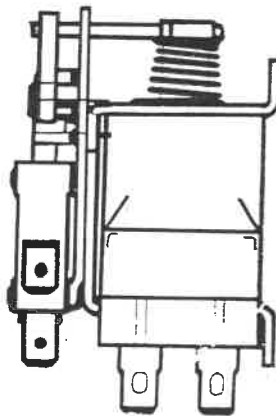

804,200,19x.x1

The sequence relay is located on a bracket adjacent to the Vend Relay (credit relay) on the main door and secured with two (2) screws.

When a credit is set up by the Coin Changer and the vend relay is energized, the normally open vend relay switch #2 closes and completes the sequence relay coil circuit.

The sequence relay coil circuit is broken when any select buttons are pushed, opening the normally open contact in the sequence relay coil circuit.

VEND MOTOR WIDE COLUMN

Mounted on the Vender with the Vend Switch on the left side (See Fig. 3). The Linkage and Drive Arm assembly is used to connect the Vend Motor to the Oscillator. (See Fig. 4)

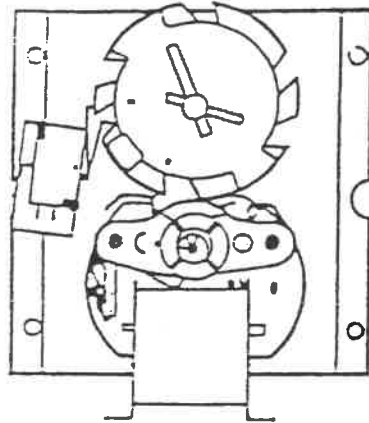

Vend Motor Switch
804,100,69x.x1 - Single Price
804,100,73x.x1 - SIID

Vend Motor - Wide Column
609,070,60x.x3 - Single Price
609,070,70x.x3 - SIID

Fig. 3

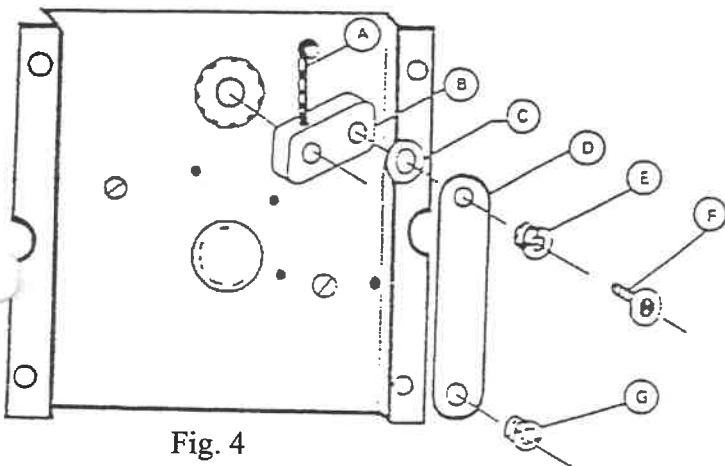
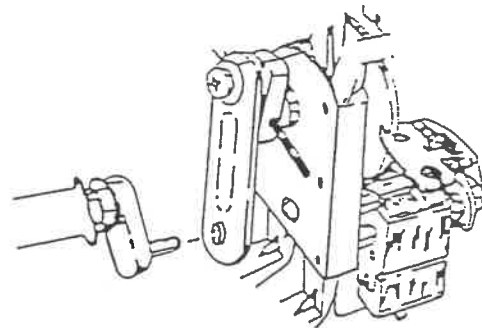

Fig. 4

- | | |
|------------------------|----------------|
| A Drive Pin | 900,901,94x.x1 |
| B. Drive Arm, Zinc | 801,200,95x.x1 |
| C. Washer | 900,700,60x.x1 |
| D. Linkage Arm, Zinc | 801,201,59x.x1 |
| E. Nyliner (Top) | 901,803,16x.x1 |
| F. Truss Screw #8-32x½ | 900,301,64x.x1 |
| G. Nyliner (Bottom) | 901,804,77x.x1 |



Nyliner (Rear Stack)
801,803,17x.x1



Nyliner (front stack)
901,804,23x.x1

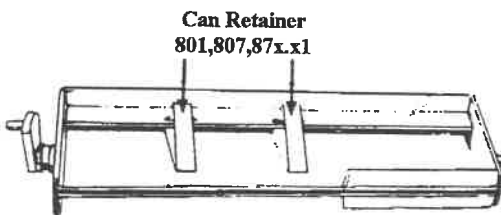

Can Retainer
801,807,87x.x1

Oscillator Assembly
609,070,50x.x3 - Bottles
609,070,40x.x3 - Cans (shown)

Sold Out Spring
901,700,74x.x1

Sold-Out Switch Assy. Snap In
804,100,68x.x1 - Single Price
804,100,75x.x1 - SIID
(Insulator and Switch are one piece)

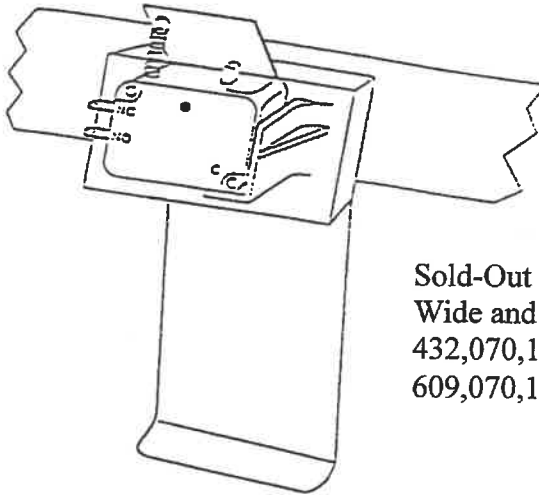

Sold-Out Paddle
Wide and Narrow
432,070,19x.x3 - Standard
609,070,19x.x3 - Special use only

VEND MOTOR NARROW COLUMN

Mounted on the Vender with the Vend Motor Switch on the underside (See Fig. 1). The shaft of the Vend Motor slides into a slot in the Vend Rotor (See Fig. 2).

Vend Motor Switch
804,100,69x.x1 - Single Price
804,100,73x.x1 - SIID

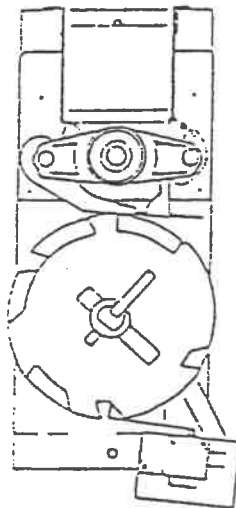

Fig. 1

Vend Motor - Narrow Column
609,070,80x.x3 - Single Price
609,070,90x.x3 - SIID

Vend Rotor
801,201,56x.x1

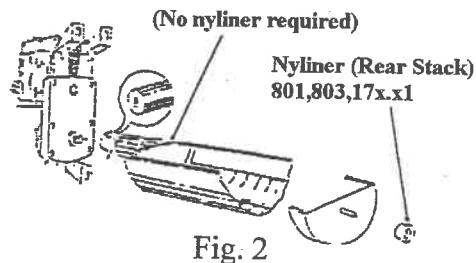

Fig. 2

E-MODEL SHIMMING

Package	Model	Loading Depth	Cam(s) Setting	Wide Column Shims	Cam(s) Setting	Narrow Column Shims	Rear Spacer
12 oz. Can 2.60" x 4.84"	501E 600E 276E	3	grey/red (#2)	Shim, 3/16 Flat (801,809,72x.x1) 2 per side	brown (#1)	Shim, Can Stop (609,070,14x.x3) 1 per right side Assy, Bottle Rod (609,070,30x.x3) 1 per rotor - "B" hole	#13
20 oz. PET Pepsi Quick Slam 2.89" x 8.60"	501E 600E 276E	2	grey/red (#3)	Shim, 3/32 Flat (801,809,81x.x1) 2 per side	brown (#5)	Shim, Bottle (609,070,15x.x3) 1 per right side	#21
20 oz. PET Coke Contour 2.86" x 9.03"	501E 600E 276E	2	grey/red (#3)	Shim, 3/32 Flat (801,809,81x.x1) 1 per side	brown (#5)	Shim, Bottle (609,070,15x.x3) 1 per right side	#24
20 oz. PET All Sport 2.88" x 8.18"	501E 600E 276E	2	grey/red (#3)	Shim, 3/32 Flat (801,809,81x.x1) 1 per side	brown (#5)	Shim, Bottle (609,070,15x.x3) 1 per right side	#18
20 oz. PET Powerade 2.86" x 7.74"	501E 600E 276E	2	grey/red (#3)	Shim, 3/32 Flat (801,809,81x.x1) 2 per side Extension Oscillator Paddle w/bottle stop (324,010,21x.x3) 1 screw, #8-18x3/4 (900,302,02x.x1)	brown (#5)	Shim, Bottle (609,070,15x.x3) 1 per right side Can/Bottle Chute Assy. w/extensions (609,072,50x.x3 wide or 615,070,60x.x3 narrow) 1 per vender	#15
20 oz. PET Straight Wall 2.89" x 8.0"	501E 600E 276E	2	grey/red (#3)	Shim, 3/32 Flat (801,809,81x.x1) 1 per side	brown (#5)	Shim, Bottle (609,070,15x.x3) 1 per right side	#18
16 oz. Glass Non Returnable 2.95" x 7.2"	501E 600E 276E	2	grey/red (#1)	Shim, 3/32 Flat (801,809,81x.x1) 1 per side	brown (#5)	Shim, Bottle (609,070,15x.x3) 1 per right side	#12
20 oz. PET Mt. Shasta 2.89" x 8.0"	501E 600E 276E	2	(#3)	Shim, 3/32 Flat (801,809,81x.x1) 1 per side	(#5)	Shim, Bottle (609,070,15x.x3) 1 per right side	#17
20 oz. PET Aqua Fina 2.86" x 8.63"	501E 600E 276E	2	grey/red (#3)	Shim, 3/32 Flat (801,809,81x.x1) 2 per side	brown (#5)	Shim, Bottle (609,070,15x.x3) 1 per right side	#21
20 oz. PET Sprite Bottle 2.89" x 9.06"	501E 600E 276E	2	(#3)	Shim, 3/32 Flat (801,809,81x.x1) 1 per side	(#5)	Assy, Bottle Divider - 1 per column (609,072,30x.x3) - 501E/276E (609,072,40x.x3) - 600E Shim, Bottle (609,070,15x.x3) 1 per right side	#22

Package	Model	Loading Depth	Cam(s) Setting	Wide Column Shims	Cam(s) Setting	Narrow Column Shims	Rear Spacer
16.9 oz. PET Perrier Water Bottle 2.51" x 8.0" Arrowhead, Calistoga, Ice Mountain, Deer Park, Poland Springs, Zephyrhills, Ozarka Logos	501E 600E 276E	2	(#3)	Shim, 3/16 Flat (801,809,72x.x1) 2 per side Shim, 3/32 Short Flat (801,809,81x.x1) 1 per side Extension Oscillator Paddle w/ bottle stop (324,010,21x.x3) 1 Screw, #8-18x3/4 (900,302,02x.x1)	(#3)	Shim, Can Stop (609,070,14x.x3) 1 per right side Assy, Bottle Divider (609,072,30x.x3) - 501E/276E (609,072,40x.x3) - 600E 1 per column Assy, Bottle Rod (609,070,30x.x3) - 2 per rotor, 1 with red tube (801,903,23x.x1) in hole A & 1 with white tube (801,903,24x.x1) in hole C. Shim, Bottle (609,070,15x.x3) 1 per right side	#18
20 oz. PET "Angle" 2.89" x 9.03"	501E 600E 276E	2	grey/red (#3)	Shim, 3/32 Flat (801,809,81x.x1) 1 per side	brown (#5)	Assy, Bottle Neck Guide (609,072,80x.x3) - 501/276E (610,071,30x.x3) - 600E 1 per column Front Guide Strip (801,810,57x.x1) - 501E/276E (801,810,58x.x1) - 600E 1 per column Vertical Metal Guide Clip (800,902,40x.x1) 2 per column Shim, Bottle (609,070,15x.x3) 1 per right side Note: Remove rear package retainer from bottom of rotor. Can/Bottle Chute Assy. with extensions (615,070,60x.x3 narrow or 609,072,50x.x3 wide) 1 per vender	#24
20 oz. PET Gatorade 2.86" x 7.76"	501E 600E 276E	2	grey/red (#3)	Shim, 3/32 Flat (801,809,81x.x1) 1 per side Extension Oscillator Paddle with bottle stop (324,010,21x.x3) 1 Screw, #8-18x3/4 (900,302,02x.x1)	brown (#5)	Shim, Bottle (609,070,15x.x3) 1 per right side Note: Remove rear package retainer from bottom of rotor. Can/Bottle Chute Assy. with extensions (615,070,60x.x3 narrow or 609,072,50x.x3 wide) 1 per vender	#15
20 oz. PET 7UP "Splash" 2.93" x 8.92"	501E 600E 276E	2	grey/red (#3)	Shim, 3/32 Flat (801,809,81x.x1) 1 per side	brown (#5)	Shim, Bottle (609,070,15x.x3) 1 per right side Assy, Bottle Divider (609,072,30x.x3) - 501E/276E (609,072,40x.x3) - 600E 1 per column	#22

Package	Model	Loading Depth	Cam(s) Setting	Wide Column Shims	Cam(s) Setting	Narrow Column Shims	Rear Spacer
16 oz. NR "Wide Mouth" Glass Bottle 2.87" x 6.84"	501E 600E 276E	2	grey/red (#3)	Shim, 3/32 Flat (801,809,81x.x1) 1 per side	brown (#5)	Shim, Bottle (609,070,15x.x3) 1 per right side	#11
20 oz. PET Surge/Bolt 2.90" x 9.03"	501E 600E 276E	2	grey/red (#3)	Shim, 3/32 Flat (801,809,81x.x1) 1 per side	brown (#5)	Shim, Bottle (609,070,15x.x3) 1 per right side	#23

ADJUSTMENTS – CAMS / REAR SPACERS

CAMS FOR VEND MOTORS

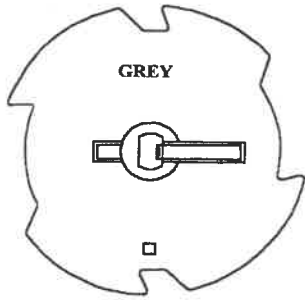

- 1. Vending Cam For:**
- a. DNCB E-Models double or triple depth wide column.
 - b. Color of Cam is Grey.
 - c. Part# 801,809,80x.x1

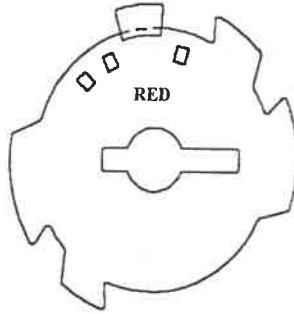

- 2. Adjustable Cam For:**
- a. DNCB E-Models double or triple depth wide column.
 - b. Color of Cam is Red.
 - c. Part# 801,809,79x.x1



- 3. Vending Cam For:**
- a. DNCB E-Models single, double, or triple depth narrow column.
 - b. Color of Cam is Brown.
 - c. Part # 801,806,18x.x1

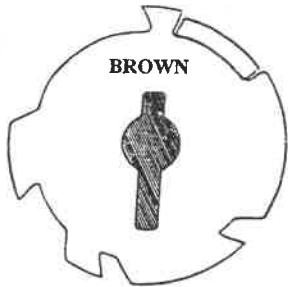

- 4. Adjustable Cam For:**
- a. DNCB E-Models single, double, or triple depth narrow column.
 - b. Color of Cam is Brown.
 - c. Part # 801,806,61x.x1

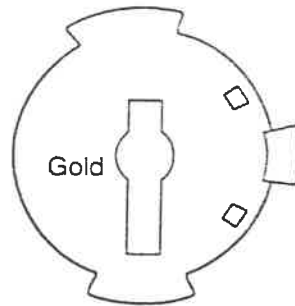

- 5. Adjustable Cam For:**
- a. DNCB E-Models single or double depth wide column.
 - b. Color of Cam is Gold.
 - c. Part #801,806,40x.x1

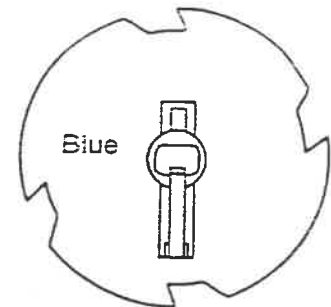

- 6. Vending Cam For:**
- a. DNCB E-Models single or double depth wide column.
 - b. Color of Cam is Blue.
 - c. Part #801,806,39x.x1

CAM INSTALLATION AND REMOVAL

TO INSTALL A VENDING CAM

1. Select the Vending Cam required (See page 24).
 2. Locate the Hub at the center of the Cam (See Fig. 6).
 3. With the Hub facing you, slowly slide the Cam on the front shaft of the Vend Motor while depressing the Lock Tab. (See fig. 6).
- NOTE: Reference below for timing of the Motors.
4. A distinct click will be heard, when the tab has locked into the locator hole of the Motor shaft.

CAUTION: Depress the Switch Arm when installing the Cam to prevent possible damage to the Switch Arm.

TO INSTALL AN ADJUSTABLE CAM

1. Select the Adjustable Cam required. (See page 24).
2. Locate the Lift Tab on the outer edge of the Cam. (See fig. 5).
3. With the Lift Tab facing you, align the slot of the adjustable Cam with the Locking Tab of the vending Cam.
4. Place the Adjustable Cam on the Vending Cam.

CAUTION: Depress the Switch Arm when installing the Cam to prevent possible damage to the Switch Arm.

5. Lift the Lock Tab of the Vending Cam, at the same time lift the Lift Tab of the Adjustable Cam and rotate the Adjustable Cam clockwise to the desired setting.

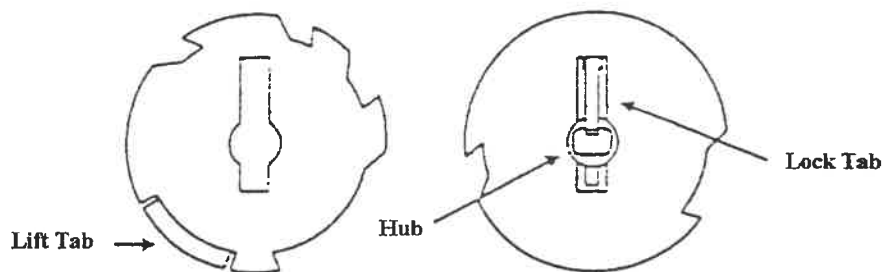

Fig. 5
Adjustable Cam

Fig. 6
Vending Cam

TO REMOVE AN ADJUSTABLE CAM

1. Lift the Lift Tab and rotate the Adjustable Cam clockwise until the Vending Cam Lock Tab is aligned with the slot of the Adjustable Cam.
2. Remove the Adjustable Cam from the shaft of the Motor.

TO REMOVE THE VENDING CAM

1. Depress (push in) the Lock Tab firmly to disengage it from the Motor shaft.
2. At the same time pull the Vending Cam towards you until it is removed from the Motor shaft.

TIMING

TO SET THE TIMING OF A NARROW COLUMN VEND MOTOR:

1. Make sure the hole through the rear shaft is in a horizontal plane. (If a pin were inserted in the hole, the pin would be horizontal.) See Fig. 8.
2. The Vend Rotor must be in the loading position when the Motor shaft is inserted in the end of the Rotor. See Fig. 8.
3. Insert the Motor shaft in the Rotor and secure the Motor.
4. Install the Vending Cam on the front shaft of the Motor making sure the Lock Tab is at the 9 o'clock position. See Fig 7.
5. Install the Adjustable Cam per the instructions given on the previous page.

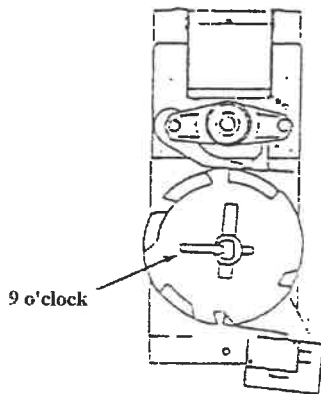

Fig. 7

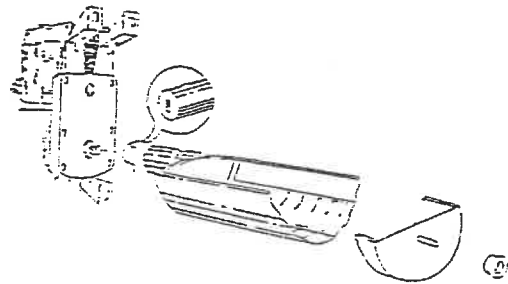

Fig. 8

TO SET THE TIMING OF A WIDE COLUMN VEND MOTOR:

1. Make sure the hole through the rear shaft is in a horizontal plane. (If a pin were inserted in the hole, the pin would be horizontal). See Fig 10.
2. Slide the Drive Arm (with linkage attached) on the rear shaft as shown. See Fig. 10.
3. Secure by installing the Groove Pin.
4. With the Oscillator in position, align the hole in the Linkage Arm with the pin of the Oscillator.
5. Slide the Linkage on the pin.
6. Install the Vending Cam on the front shaft of the Motor making sure that the Lock Tab is at 6 o'clock as shown. See Fig. 11.

NOTE: When the screw holding the Linkage Arm to the Drive Arm is at the 12 o'clock position (See Fig. 10), the Lock Tab will be at the 6 o'clock position (See Fig. 11).

7. Install the Adjustable Cam per the instructions on the previous page.

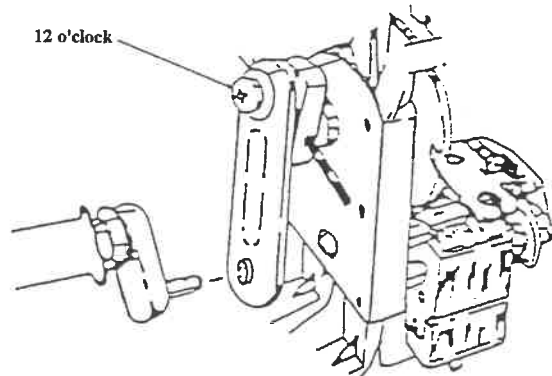

Fig. 10

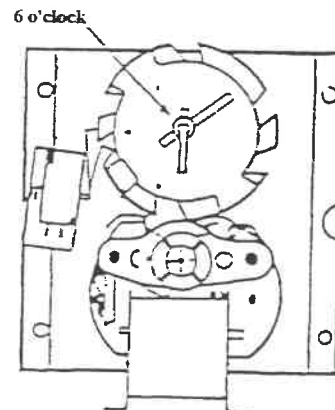
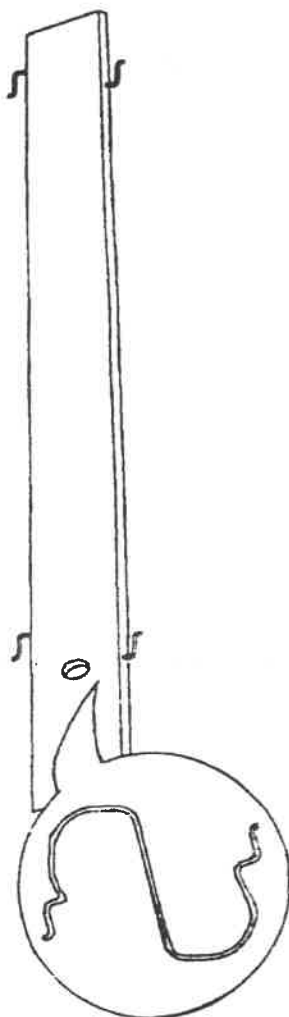

Fig. 11 Page 26 of 72

REAR SPACER

The Rear Spacer, one for each column, is located vertically at the rear of the column. The Springs, adjustable by hand, slide into the holes in the column wall for cans and other package settings.



Rear Spacer Assembly
 497,073,90x.x3 - Wide 600E
 498,071,30x.x3 - Wide 501E
 497,073,70x.x3 - Narrow 600E
 498,071,40x.x3 - Narrow 501E/276E

FOR REFERENCE ONLY

Rear Spacer adjustment holes located in the sidewalls of the stacks.

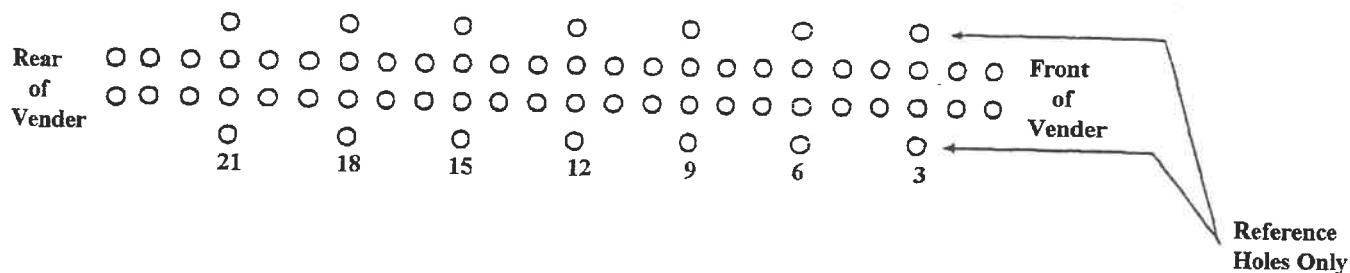

VEND CYCLE / SEQUENCE OF OPERATION

VEND CYCLE SINGLE PRICE

WHAT DOES IT	WHAT HAPPENS
1. Insert a coin.	1. Coin travels in the coin mechanism.
2. The coin.	2. Activates the coin vend switch or coin sensor and....
3. The normally open contact of the coin vend switch or sensor.	3. Closes and completes the vend relay coil circuit.
4. The vend relay coil is energized and ...	4. The normally open contact of vend relay switch #3 is closed, keeping the vend relay energized. The normally closed contact of the vend relay switch #1 is opened in the coin changer inhibit circuit. The normally open contact of the vend relay switch #2 is closed in the select panel circuit.
5. The coin vend switch or sensor resets and the normally closed contact of the coin vend switch or sensor...	5. Allows power to flow to the select panel and on some models completes the sequence relay coil circuit.
6. A select button is pushed and the normally open contact in the select switch...	6. Closes and completes the circuit to the vend motor coil. The sold out light illuminates. The vend motor begins to run.
7. A short time later, the arm of the by-pass switch...	7. Drops into the notch of the cam and the normally open contact of the by-pass switch opens in the select panel circuit.
8. The normally open contact of the vend relay switch #3...	8. Opens in the vend relay coil circuit.
9. The normally open contact of the vend relay switch #2....	9. Opens in the vend motor coil circuit and opens and breaks the select panel circuit.
10. The normally closed contact of the vend relay switch #1....	10. Closes in the coin changer circuit and..
11. The normally closed contact of the by-pass switch...	11. Closes and completes the circuit to the vend motor coil.
12. The vend motor....	12. Continues to run.

WHAT DOES IT	WHAT HAPPENS
13. The vending cam...	13. Works the arm of the vend motor switch and the switch arm rises to the high side of the cam.
14. The normally closed contact of the vend motor switch opens.	14. And
15. The normally open contact of the vend motor switch closes.	15. The sold out lamp turns on and the vend motor circuit receives power to keep the motor running.
16. A short time later, the arm of the by-pass switch rides to the high side of the cam.	16. And
17. The normally open contact of the by-pass switch closes	17. Enabling the coin changer.
18. The vending cam	18. Continues to work the arm of the vend motor switch and the switch arm drops into the notch of the cam.
19. The normally open contact of the vend motor switch opens	19. Breaking the sold out lamp and vend motor coil circuits, the motor stops and the oscillator or rotor stops.
20. The normally closed contact of the vend motor switch closes.	20. We are back to stand-by in the vender.

**SEQUENCE OF OPERATION
SIID CONTROLLER STYLE COIN MECH
ESCROW TO PRICE AND NO BILL ESCROW (PR)**

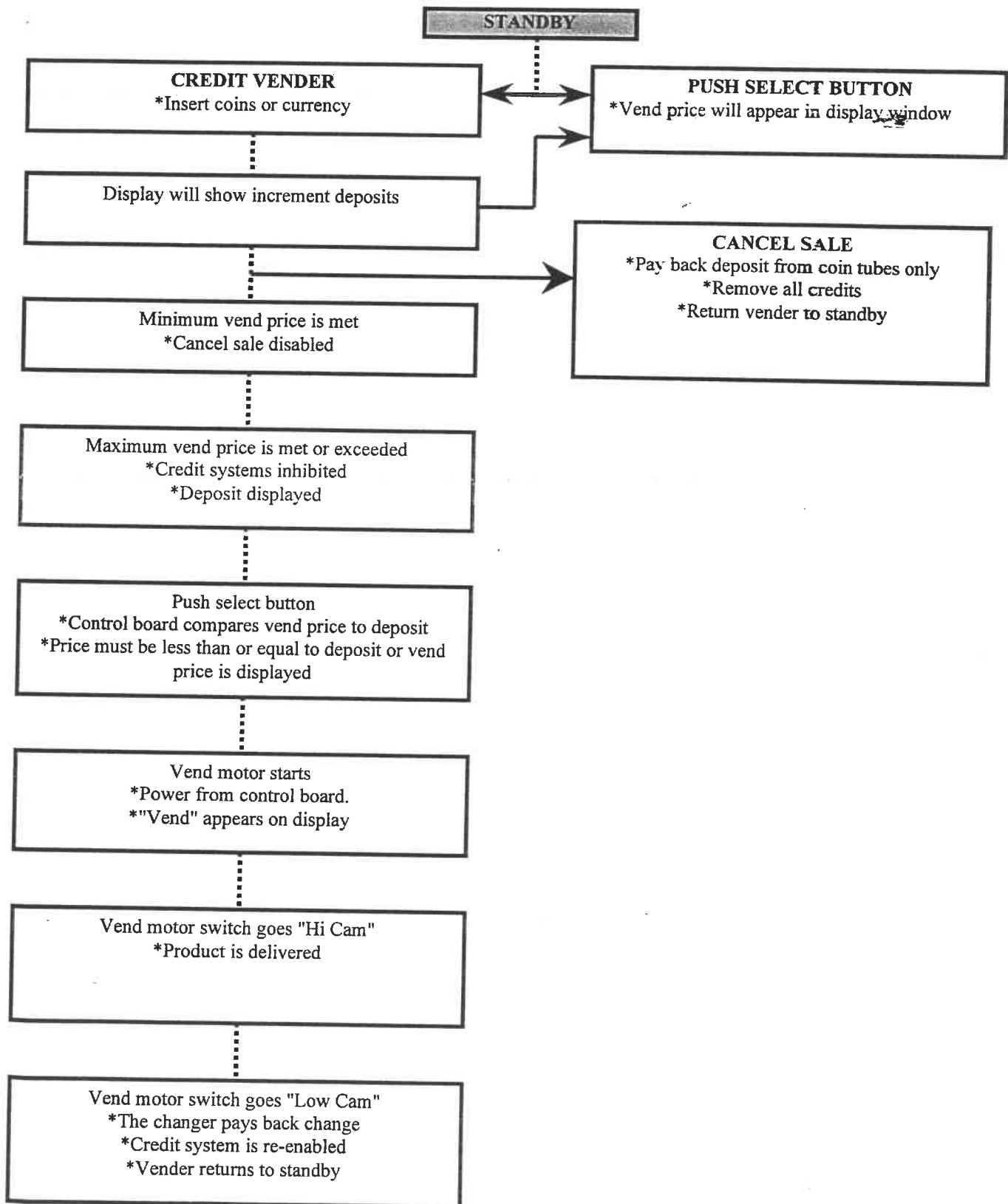

**SEQUENCE OF OPERATION
SIID CONTROLLER STYLE COIN MECH
ESCROW TO SELECT / LAST BILL ESCROW (E-S1)**

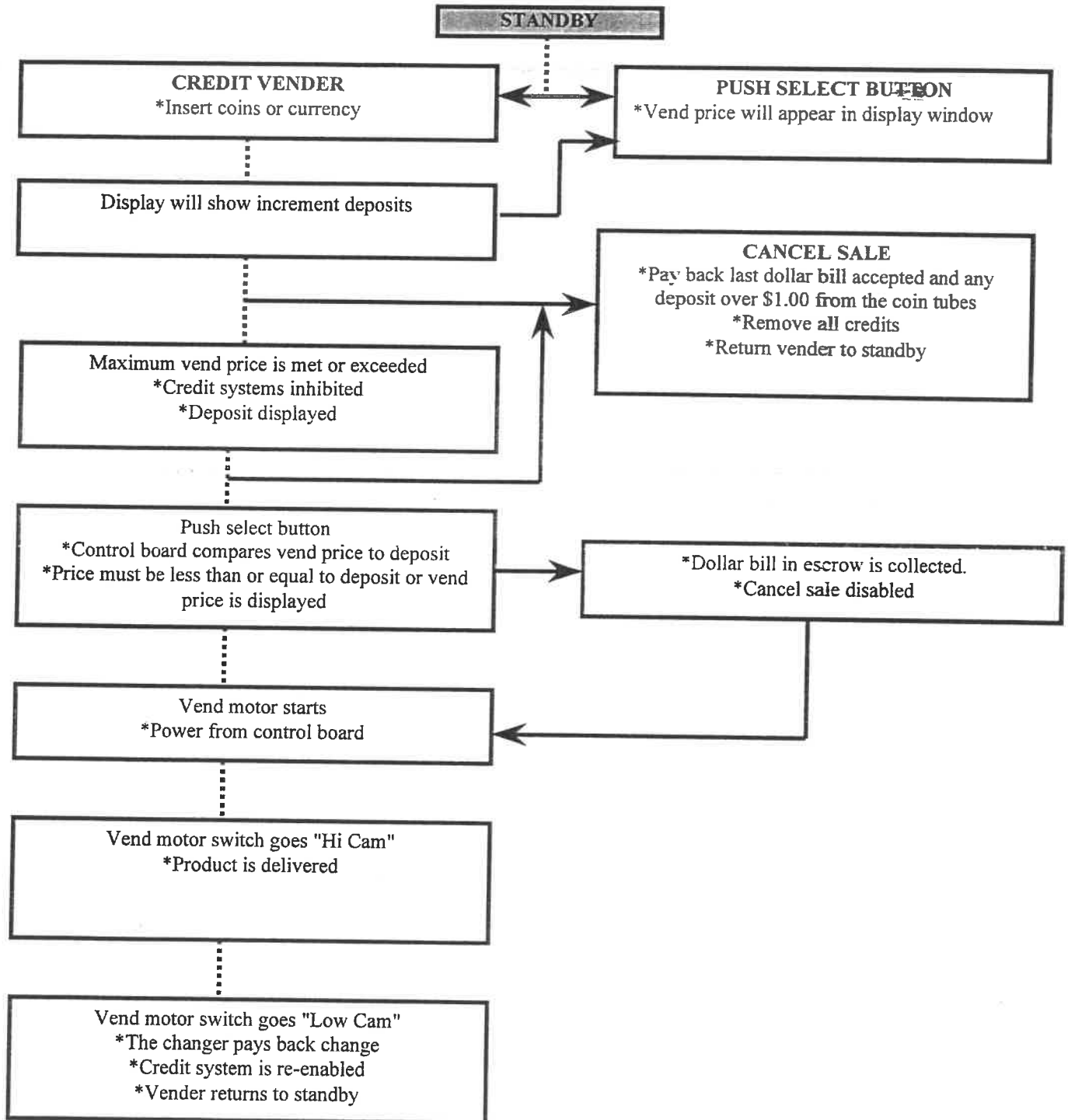

SEQUENCE OF OPERATION
SIID CONTROLLER STYLE COIN MECH
ESCROW TO SELECT / NO BILL ESCROW (E-S4)

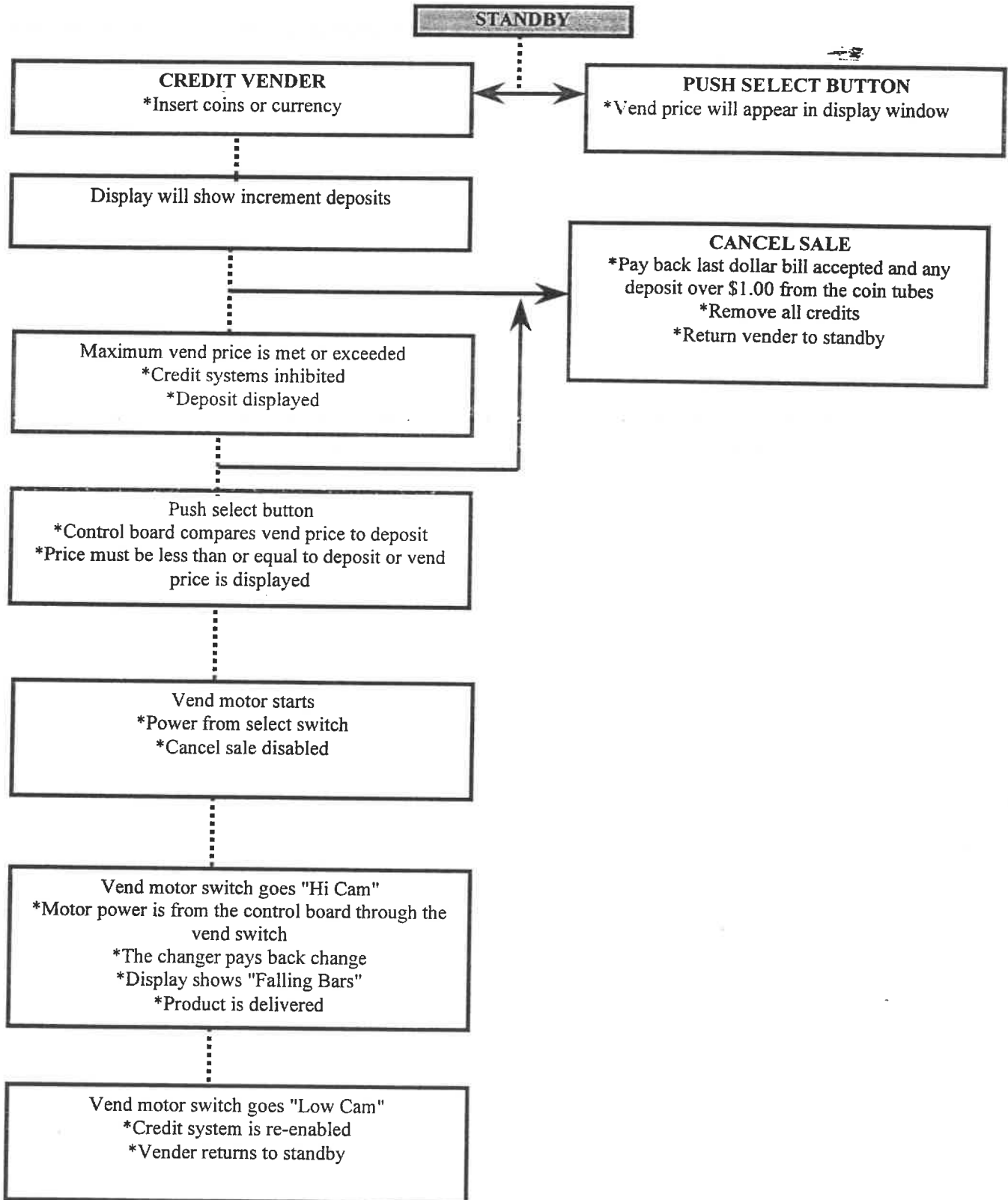

CORRECTIONS FOR COMMON SINGLE PRICE VENDER VENDING PROBLEMS

NOTE: When one or more circuits become inoperative on a Dixie-Narco vender, it is usually one component that has failed, and it is with this in mind that the accompanying troubleshooting schematic is presented.

Control Panel
Electrical Feed
Through Normally Closed of each Select Switch

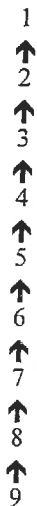

Figure 1
Control Panel
(Select Button and Select Switch Location)

The control panel shown above represents a sample of the panels used on Dixie-Narco venders.

It is **important** to keep in mind the feed of electrical current through the select switches.

On the inside of the control panel, the select buttons and switches are numbered to assist identification. If not numbered, then the select button arrangement is shown in the foregoing diagram.

Figure 1 represents a control panel on which the select buttons are arranged in a vertical pattern and the power feed begins with the highest numbered switch and proceeds to the lowest numbered switch.

ACCEPTS COINS, WILL NOT VEND FROM ONE OR MORE COLUMNS

Although all circuit problems are not necessarily found to be one or more inoperative select switches, the examples listed below are typical of select switch problems found in the control panel. Refer to figure 1 on page 33.

Problem 1: Selections 9, 8, and 7 work.
Selections 6, 5, 4, 3, 2, and 1 do not work.
Recall the feed of the electrical current.

Answer: Check the normally closed and common of select switch 7.
Check the normally open and common of select switch 6.

Problem 2: Selections 9, 8, 7, 6, 5, and 4 work.
Selections 3, 2, and 1 do not work.
Recall the feed of the electrical current.

Answer: Check the normally closed and common of select switch 4.
Check the normally open and common of select switch 3.

ACCEPTS COINS BUT WILL NOT VEND

Problem 1: All selections do not work.
Recall the feed from the electrical current.

Answer: Check the coin changer.
Check the vend relay.
Check the select switch that gets power first.

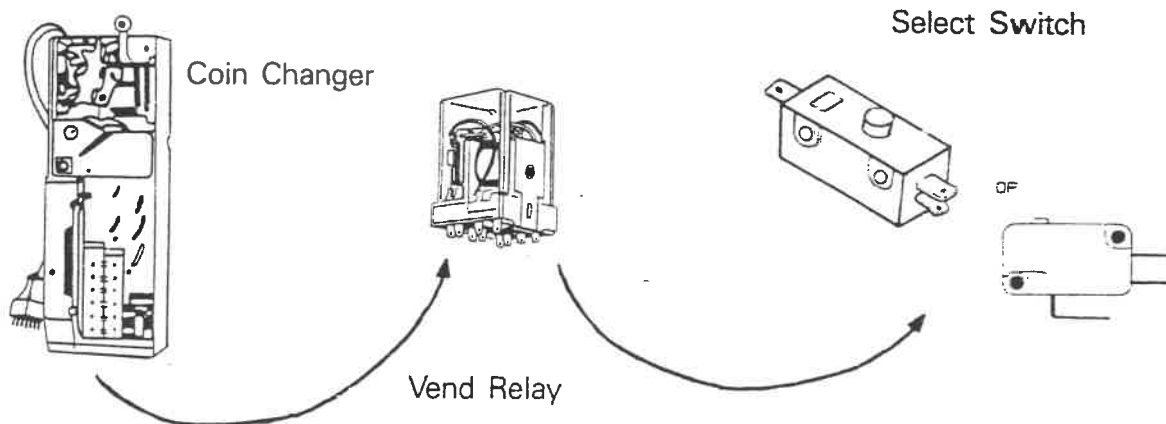

ACCEPTS COINS BUT WILL NOT VEND FROM ONE COLUMN

Problem 1: Accepts coins but will not vend from one column.

Example: Selection #3 will not vend.

Check: The normally open of select switch #3.

Note: If the sold-out lamp comes on when the button is pushed, the select switch is O.K.

Check: The sold out switch in the vending circuit.

Check: The vend motor.

Note: If the vend motor runs by depressing the vend switch, the vend motor is O.K.

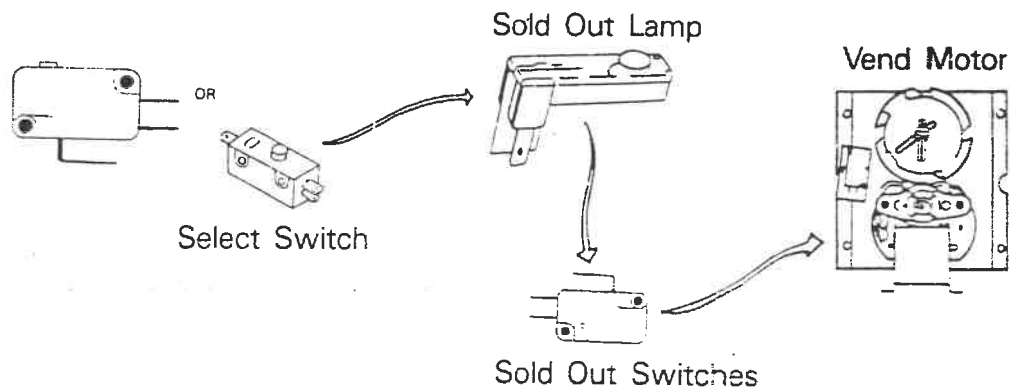

REJECTS ALL GOOD COINS

Problem 1: The coin changer will not accept coins.
Put product in each column.
Follow the arrow WHICH IS THE DIRECTION OF FLOW OF THE ELECTRICAL CURRENT. (See figure below)

DO THIS:

1. Make sure there is product in each column. The sold out lamps are off.
2. Follow the arrows from left to right.
3. a. Push vend motor switch - motor D - Vend Motor cycles.
b. Push vend motor switch - motor C - Vend motor does not cycle.
The problem is the vend motor switch and by-pass switch on motor C and/or motor D.
c. If the problem is not found, continue this procedure through motors B and A.
d. If the problem is not found, replace the vend relay.
e. If the problem is not found, the last component to check would be the coin changer.

Coin Changer

Sold Out Switches

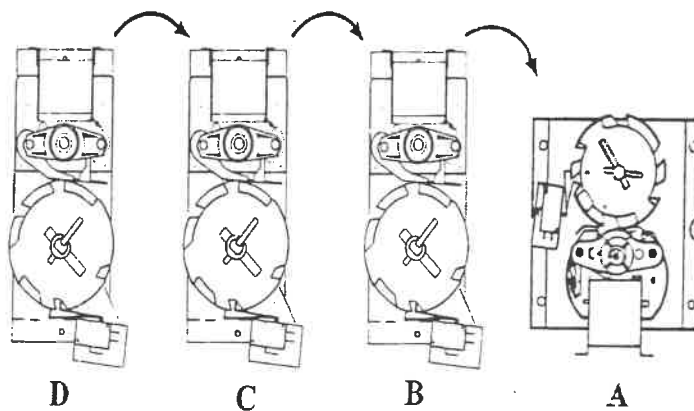
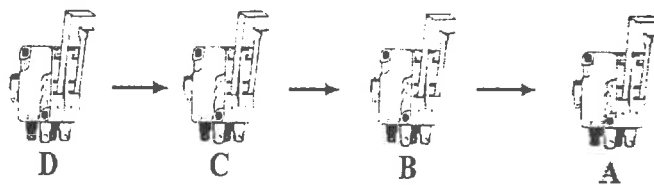
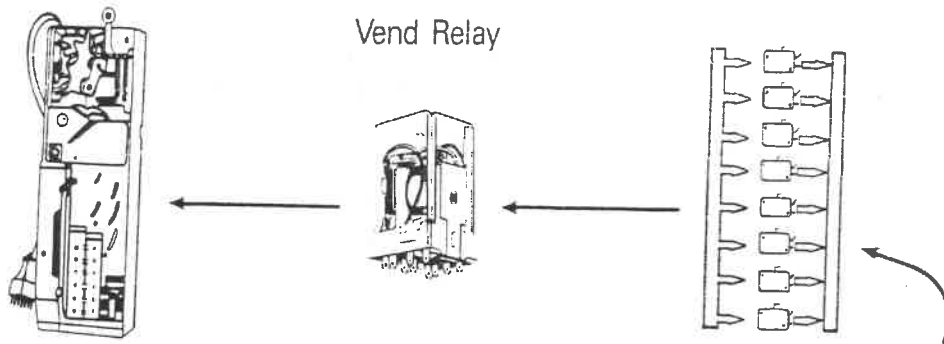

DRIFTING MOTOR AND JACK-POTTING PROBLEM

SYMPTOM	THINGS TO CHECK	IF FAULTY, WHAT TO DO
1. The vend motor drifts: Both switch arms drop into the cam notch and the vend motor keeps running.	A. Vend Motor Switch B. Vend Motor Switch Arm relationship to the cam. C. Check the pawl for looseness. It should be loose. D. Pawl Spring. E. Actuator should be loose.	A. Replace the switch. B. If too close to the cam, bend the arm away from the cam slightly or replace the switch. C. If tight, replace. D. If off, correct. If elongated, replace. E. If actuator sticks to stator due to syrup, clean stator. If tight, clean at the pivot. If still tight, replace the motor.
2. Two beverages delivered in a cycle and the next cycle is a dry vend.	A. Shimming. B. Cam Setting.	A. Correct. B. Correct.
3. Two beverages delivered in a given cycle.	A. Shimming B. Cam Setting. C. Follow checking procedure for a drifting motor.	A. Correct. B. Correct. C. Correct.
4. Pre-Select, i.e. set up credit, push no button and product is vended time after time.	A. Select Switch; Sticking, incorrectly wired, or bad.	A. Replace or Correct.

**ACCEPTS COINS AND WILL VEND,
THEN REJECTS COINS BUT WILL CONTINUE TO FREE-VEND**

<u>Problem 1:</u>	Set up Credit	Push a Selection	It will vend
		Push same Selection	It will vend
	Rejects coins	Push same selection	It will continue to vend

Reason: The by-pass switch is not canceling the credit.

<u>Check:</u>	The by-pass switch electrically	If faulty	replace
	The by-pass switch for a sticking plunger	If faulty	replace
	The by-pass for incorrect wiring	If faulty	correct
	Set-Up credit	Push a selection	It vends
	Push same selection	It does not vend	

TROUBLESHOOTING

SIID VENDING

1. **Problem:** Free vend on one column.
Troubleshooting:
 - A) Check selection price.
 - B) Check for bad connections or broken, backed out, or crossed wires from vend motor to control board.
 - C) Check for sticking select button.
 - D) Check control board.

2. **Problem:** One motor continues to home with door closed, shows "JC=" when in diagnostics or "COLJ" when "ErOr" routine is entered.
Troubleshooting:
 - A) If using Mars Validator, ensure correct interface harness is used.
 - B) Check for bad connections or broken, backed out, or crossed wires from vend motor to control board. (Note: Check wires on left side of vend motor cover.)
 - C) Vend switch.
 - D) Check control board.

3. **Problem:** One column sold out, but still vends.
Troubleshooting:
 - A) Check sold-out switch.
 - B) Check for bad connections or broken, backed out, or crossed wires from sold-out switch to control board. (Note: Check wires on left side of vend motor cover.)

4. **Problem:** Vender will not sequence (Coca-Cola only).
Troubleshooting:
 - A) Ensure wire #24 is in select panel harness and is in correct pin location.
 - B) Check for bad connection or broken wire #24 in select panel harness.
 - C) Make sure wire #24 is in correct location.
 - D) Check control board.

5. **Problem:** Free vend on one or more columns.
Troubleshooting:
 - A) Check secondary pricing program.
 - B) Check for bad connections or broken, backed out, or crossed wires from vend motor to control board.
 - C) Check for sticking select button.
 - D) Check for bad vend motor switch.
 - E) Check control board.

6. **Problem:** Column Jackpots.
Troubleshooting:
 - A) Check problem column(s) in motor test.
 - B) Check motor for:
 1. Syrup on brake.
 2. Locate/check brake spring.
 3. Check motor switch.
 - C) Check wiring from/to motor switch of problem column.
 - D) Check wiring at mate-n-lock on cabinet harness and cabinet extension harness.
 - E) Check motor.
 - F) Check control board.

7. **Problem:** Column will not vend.
Troubleshooting:
 - A) Go to diagnostics and test.
 - B) Check for bad connection or broken, backed out, or crossed wires.
(Also check ballast wires)

8. **Problem:** Motor stops on high cam.
Troubleshooting:
 - A) Change vend switch.
 - B) Install current software.
-5 or 380.11 or greater two-button programming.
-3.16 or 390.11 or greater four button programming.

9. Problem: No motors work.

- Troubleshooting:
- A) Check F2 motor power fuse (6 amp).
 - B) Check lamp and lamp wiring for broken, backed out, or crossed wires.
 - C) Check ballast and ballast wiring for broken, backed out, or crossed wires.

10. Problem: F2 Motor Power fuse continuously blows.

- Troubleshooting:
- A) Check if 6 amp fuse is used.
 - B) Check that capacitor instead of MOV used at CR1 location.
 - C) Check ohms of each motor in off state
 - unplug wires to coil of motor.
 - ohms should be 6.5, if less coil of motor has a short.
 - D) Check motor harness.
 - E) Check motor extension harness.
 - F) Check for bad bulb in lighting system.

SIID COIN / CURRENCY

1. Problem: Will not accept coins or bills.

- Troubleshooting:
- A) Check coin return lever is not pressed.
 - B) Check F3 peripheral (1.0 Amp) fuse.
 - C) Go to diagnostics and test.
 - 1. Will not take coins, replace coin mech.
 - 2. Still will not take coins, check connections and mech harness.
 - D) Check for bad connections or broken, backed out, or crossed wires from validator/changer to control board.
 - E) With Mars 6510 Mdb mechs, serialized prior to 176xxxxxxx that do not have a red dot on the coin mech, check the coin mech.
 - F) Check control board.

2. Problem: Validator sometimes sets up credit and then steals bill.

- Troubleshooting:
- A) Check for proper interface harness.
 - B) Check for bad connections or broken, backed out, or crossed wires from vend/sold-out harness.
 - C) Check validator.
 - D) Check control board.

3. Problem: Accepts coins and displays, but will not vend.

- Troubleshooting:
- A) Check coin mech.
 - B) Check for bad connections or broken, backed out, or crossed wires from validator/changer to control board.
 - C) Check voltage supply (110-115AC) at outlet.
 - D) Check control board.

4. Problem: Incorrect change paid back, use correct change lamp stays on.

- Troubleshooting:
- A) Check control board.

5. Problem: Cannot dump coins when in "Cd" mode or "CPO" mode.

- Troubleshooting:
- A) Check for bad connections or broken, backed out, or crossed wires from changer to control board.
 - B) Check select switches and wiring.
 - C) Check coin mech.
 - D) Ensure you are not using Mars International Executive or NRI Simplex changers.
 - E) Check voltage supply (110-115AC) at outlet.
 - F) Check control board.

6. Problem: BA30 stealing bills.

- Troubleshooting:
- A) Check door switch.
 - B) Check validator.
 - C) Check interface harness.

7. Problem: Want to install a debit card system.
 Troubleshooting: A) Need to contact card system supplier for details.
8. Problem: \$1 and \$5 Bill Acceptance (Black label box 2 button programming)
 Troubleshooting: A) Works with
 1. BA-30
 2. VFM-3 Low Level
 3. DBA -2 or 3
9. Problem: \$1 and \$5 Bill Acceptance (Red label box 4 button programming)
 Troubleshooting: A) Works with
 1. BA-30 Mdb
 2. Mars VN 2500 Series Mdb
10. Problem: Install bill, unplug vender, plug in vender, gives \$1 credit and bill back.
 Troubleshooting: A) Set Escrow to "Pr" or "ES-4"
 B) Install current software.
 -5 or 380.11 or greater two-button programming.
 -3.16 or 390.11 or greater four-button programming.
11. Problem: Install Debitek card, unplug vender, plug in vender, jackpots changer.
 Troubleshooting: A) Install current software.
 -5 or 380.11 or greater two-button programming.
 -3.16 or 390.11 or greater four-button programming.
12. Problem: After a few vends, the Mars 6510 Mdb disables itself (i.e. stops taking coins).
 Troubleshooting: A) Install current software (eprom) 804.911.380.41
 - 804.911.380.41 or greater two-button programming.
 - 804.911.390.21 or greater four-button programming.
13. Problem: Insert \$1.00 bill and \$2.00 or more appears on the display.
 Troubleshooting: A) Go to "nF" (note factor) in menu and set to 100 (two-button programming only).
 B) Install a known good validator.
14. Problem: New 4-tube MDB changer will not pay out dollar coin.
 Troubleshooting: A) Install current software.
 - 380.51A or 380.71 or greater two-button programming.
 - 390.11 or greater four-button programming.
15. Problem: Software does not work with free vend note token in BA30.
 Troubleshooting: A) Install current software.
 - 380.51A or 380.71 or greater two-button programming.
 - 390.31 or greater four-button programming.
16. Problem: Coinco 9302GX changer dispenses all nickels first, then correct change lights come on (sample price this occurs .60)
 Troubleshooting: A) Load the nickel tube in coin fill (CD) mode. Note: This is a Coinco 9302GX problem.
17. Problem: *Coinco BA30 programmed for coupon acceptance, accepts bill, stacks, and doesn't give any credit.*
 Troubleshooting: *This is a Coinco problem. They are never working on it.*

SIID SOLD-OUT MESSAGE

- Problem:** Sold-out message stays on.
Troubleshooting: A) Check limited access program.
B) Check for crossed wires in cabinet harness and cabinet extension harness or loose wire harness connection.
C) Check for motors rubbing motor cover (on early SIID venders).
- Problem:** Sold-out message comes on with product in column.
Troubleshooting: A) Check programming and ensure limited access is not on.
B) Check for bad connections or broken, backed out, or crossed wires from select switch to control board.
(Note: Check wires on left side of motor cover.)
C) Check for motor rubbing motor cover (on early SIID venders).
- Problem:** Sold-out switches work the incorrect column.
Troubleshooting: A) Ensure correct cabinet harness and select harness are being used.
B) Check for crossed wires in cabinet harness or cabinet extension harness.

SIID SELECT PANEL / DISPLAY

- Problem:** Plug in vender and displays a blank or "rrrr" appears on the display; vender will not function.
Troubleshooting: A) Press a select button to change message on display; this should clear.
B) Remove power to vender for one minute, then power vender back up.
C) Check main power plug for loose connection.
D) Check for bad connections or broken wires from display to control board.
E) Check display board.
F) Check control board.
- Problem:** Display will not function.
Troubleshooting: A) Check for bad connections or broken wires from display to control board.
B) Check F1 board power fuse (1.6 amp).
C) Check display board.
D) Check transformer.
E) Check control board.
- Problem:** Display shows \$1 and then increases in dollar increments with door closed
Troubleshooting: A) Check coin mech.
B) Check validator
C) Check control board.
- Problem:** Cannot set price on a given selection.
Troubleshooting: A) Check configuration code 1 is set to C1 1 (multi-pricing). (4-button programming only)
B) Check for bad connections or broken wires from select switch to control board.
C) Check select switches.
D) Check control board.
- Problem:** Vender changes a set vend price to .10¢ on selections on its own. (domestic only - .10¢ could be any given price.)
Troubleshooting: A) Check secondary pricing program.
B) Check for bad connections or broken wires from select switch to control board.
C) Check control board. (Possible cold solder joints.)
- Problem:** Control board loses its memory when power is shut off to vender.
Troubleshooting: A) Check battery (see problem 16 on next page).
B) Check control board.

7. Problem: Space to sales does not work properly when adding and deleting columns.
 Troubleshooting: A) Check for bad connections or broken wires from select switch to control board.
 B) Check control board.
8. Problem: F2 motor power fuse (6 amp) blows when a given motor runs.
 Troubleshooting: A) Check motor for short.
 B) Check motor switch and motor wires for broken, backed out, or crossed wires.
 C) Check motor.
 D) Check the ballast, lamps, and lamp harnessing for broken, backed out or crossed wires.
9. Problem: Board power fuse blows when supplying power.
 Troubleshooting: A) Check changer and interface harness.
 B) Check validator and interface harness.
10. Problem: Flashing decimal point (2-button programming); two decimals displayed (4-button programming)
 Troubleshooting: A) Go to diagnostics.
 - All columns shown to be jammed.
 - Check 6 amp motor fuse (F2).
 - Select problem.
 - Enable problem (check board).
 - Pb problem (check board).
11. Problem: Plug in vender and "1-1-1-1" scrolls across display.
 Troubleshooting: A) Remove power to vender for one minute, then power vender back up.
 B) Check for bad connections or broken, backed out, or crossed wires in select panel harness.
 C) Check top of door weld assembly for seal.
 D) Check control board.
12. Problem: Display shows "LOC".
 Troubleshooting: A) Can only be accessed via DEX or hand-held.
 B) Check control board.
13. Problem: Will not show vend price on display; decimal point is illuminated.
 Troubleshooting: A) All vend prices on primary price have to be the same price, and all prices on secondary price have to be the same price.
 - Two-Button programming: To quick-set all prices, set vend price on #1 to price you require, then press select buttons 3 and 4 and hold for 10 to 15 seconds. All prices will change to the price programmed at #1 selection. Close the door and the display will now show the vend price.
14. Problem: When programming, the display takes 30 to 45 seconds to go from one program to another.
 Troubleshooting: A) Unplug the coin mech and then program the SIID control box.
15. Problem: Display goes blank when you press a given select button.
 Troubleshooting: A) Check for bad vend motor on selection pressed. (Wire broken at coil or possible spade pulled out)
16. Problem: Set price, unplug vender, plug in vender and price changes to 99.95.
 Troubleshooting: A) Check battery. Follow steps to check.
 1. Unplug vender.
 2. On Ardac boards, locate component LH5168D-10L at U6 on board.
 On DeAmertek boards, locate component LH5168D-10L at U2 on board.
 3. Set volt meter to test DC voltage.
 4. Put one test lead on pin 14.
 5. Put other test lead on pin 28.
 6. Volt meter should read minimum 2 VDC.
 7. If bad battery (under 2 VDC), check the board.

17. Problem: When programming prices, display will only increment in \$1.00 amounts.
Troubleshooting: A) Go to "bill" (set bills only) in menu and set to "bills no" (two-button programming only).
B) Down-power the vender and plug in the coin mech.
C) Install known good coin mech.
D) Check control board.
18. Problem: All segments stay illuminated on display.
Troubleshooting: A) Toggle to proper setting (14 segment versus 7 segment).
B) Connector harness loose at display board.
C) Check for bad connection or broken, backed out, or crossed wires in display harness.
19. Problem: Plug in vender and "1-1-1" scrolls across the display. Press service switch and "EN#" is displayed.
Troubleshooting: A) Check control board.

SELECT PANEL TROUBLESHOOTING CHART

Problem: When vender powers up, I-1 scrolls on the display.

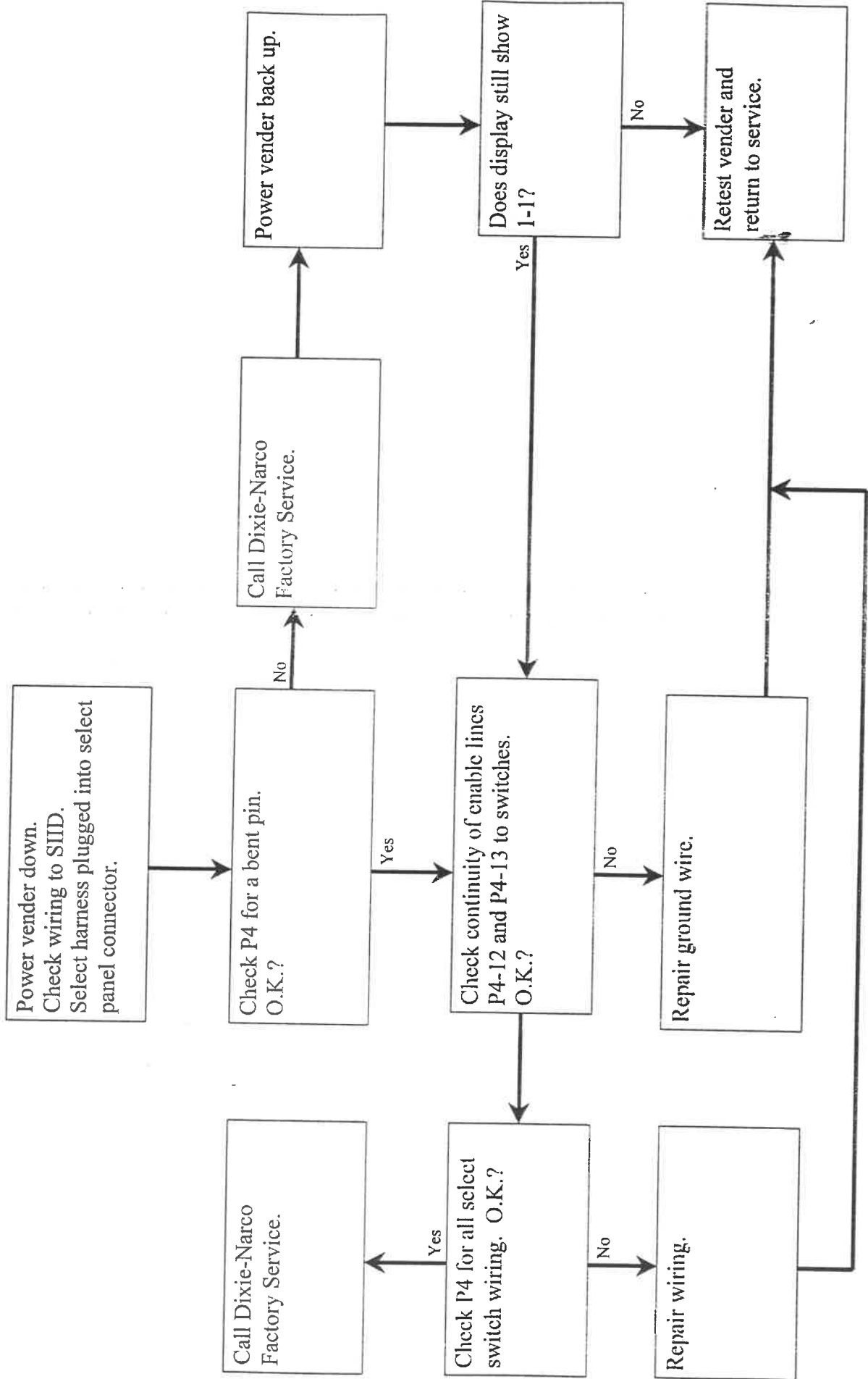

SELECT PANEL PROBLEMS

Problem: Cannot enter menu or diagnostic menu.

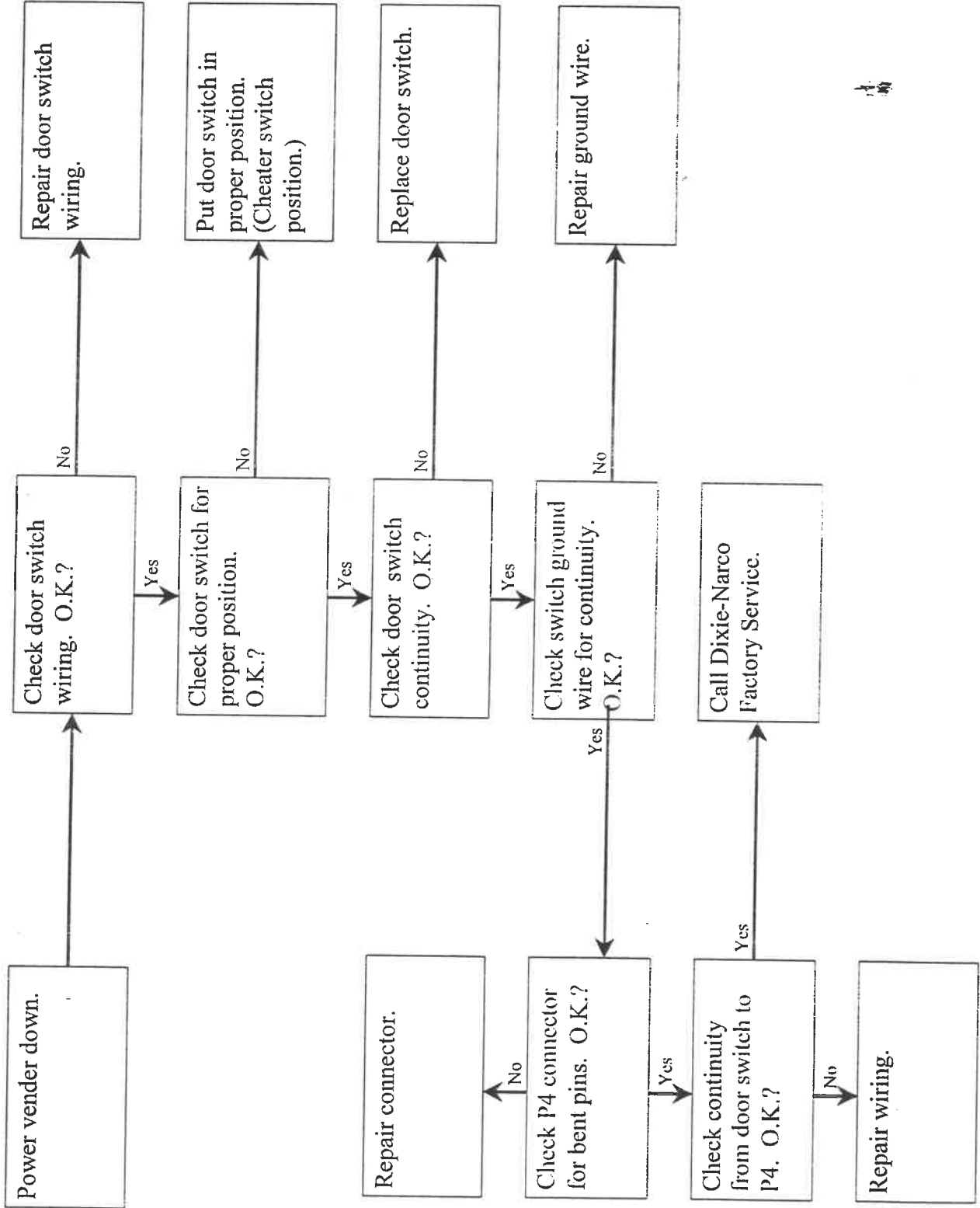

SELECT PANEL PROBLEMS

Problem: 1 or more switches not functional.

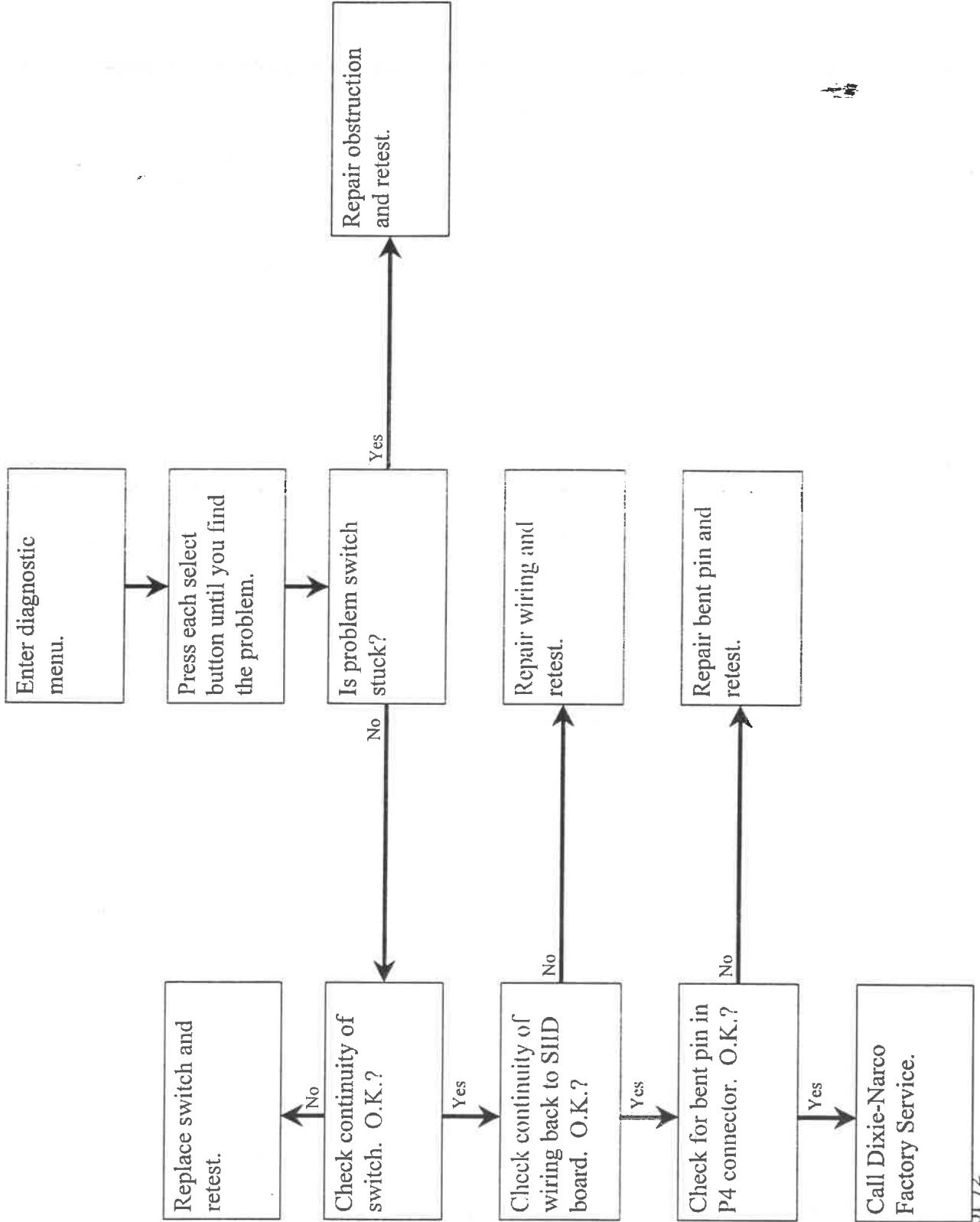

SOLD-OUT SWITCH PROBLEM

Problem: Vender will not recognize a sold-out column.

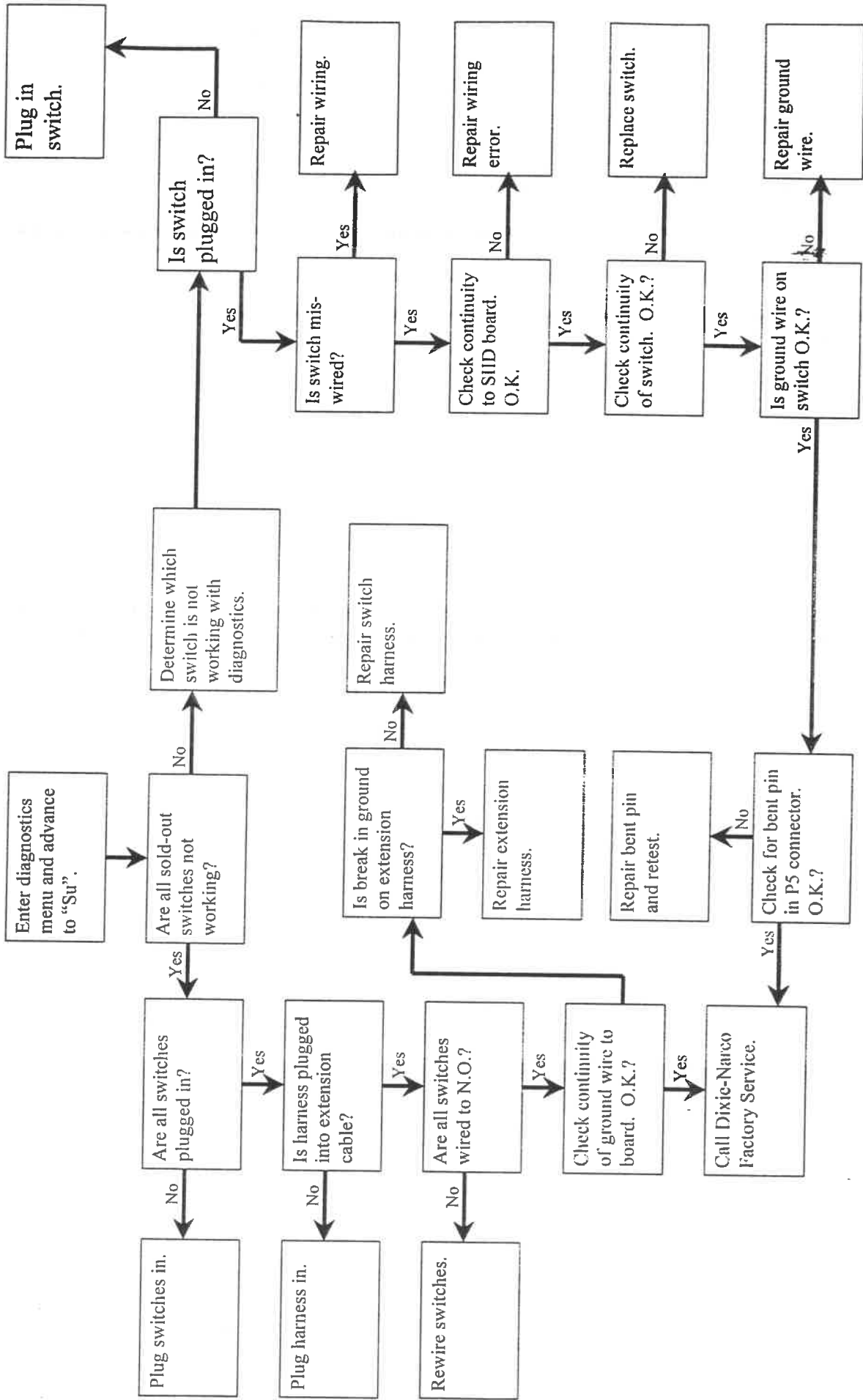

NOTE ACCEPTOR TROUBLESHOOTING USA LOW LEVEL

Problem: Acceptor will not take notes or does not display them.

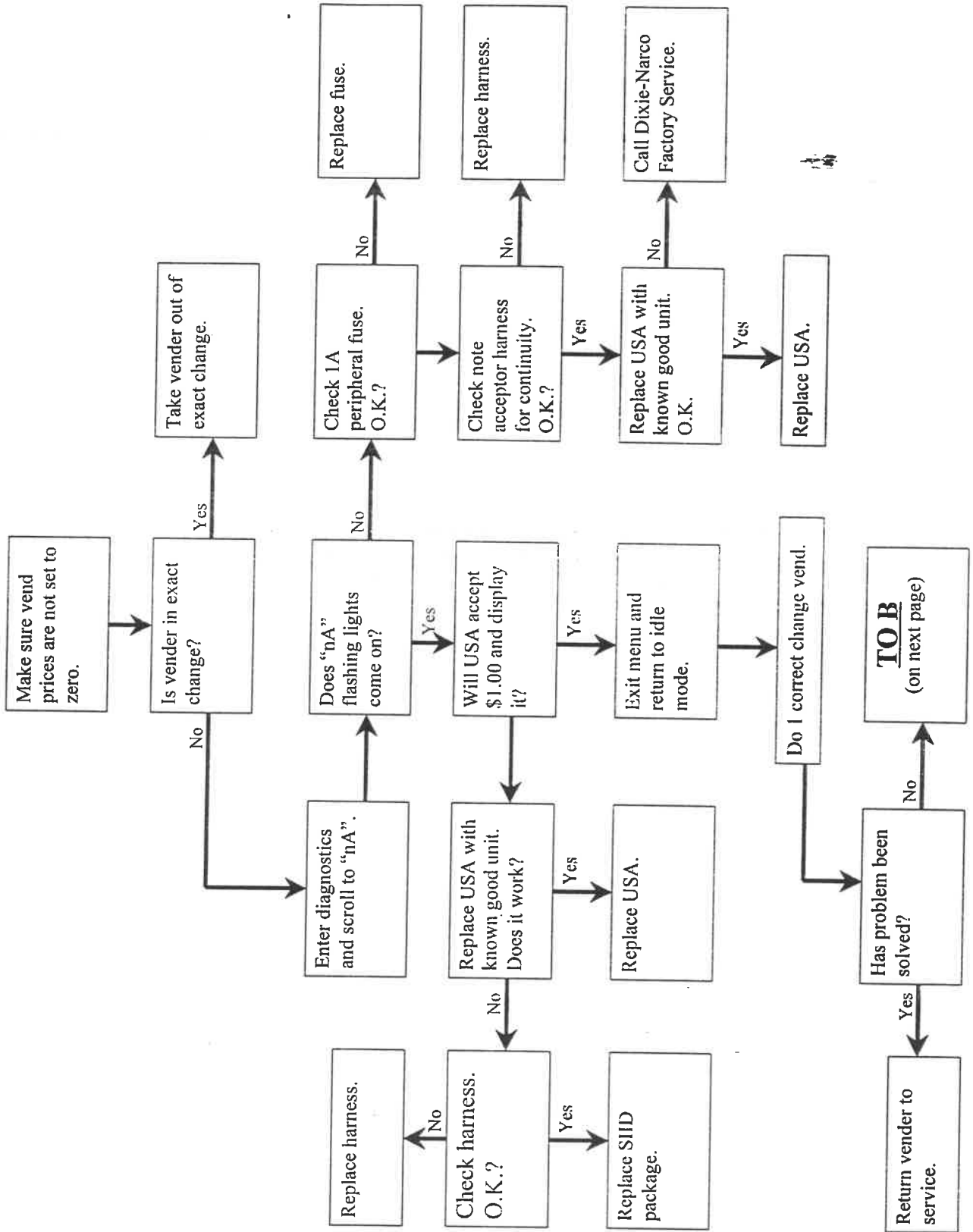

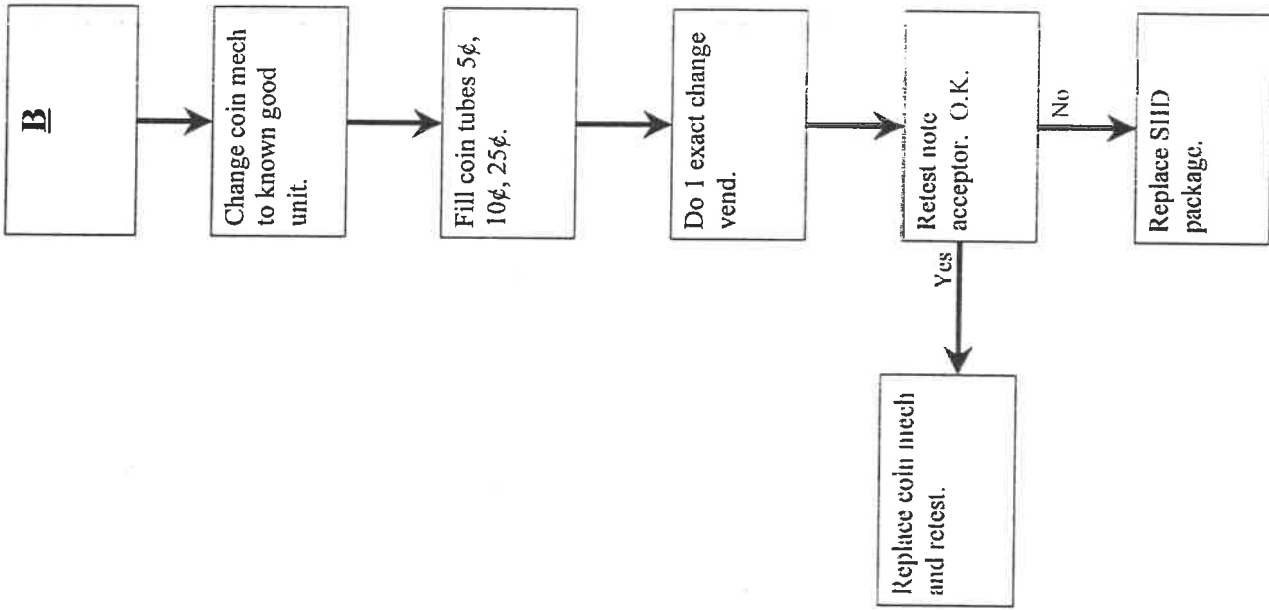

NOTE ACCEPTOR TROUBLESHOOTING MARS VFM1 OR VFM3 LOW LEVEL ACCEPTOR

Problem: Note acceptor will not accept money; or takes note and does not display credit.

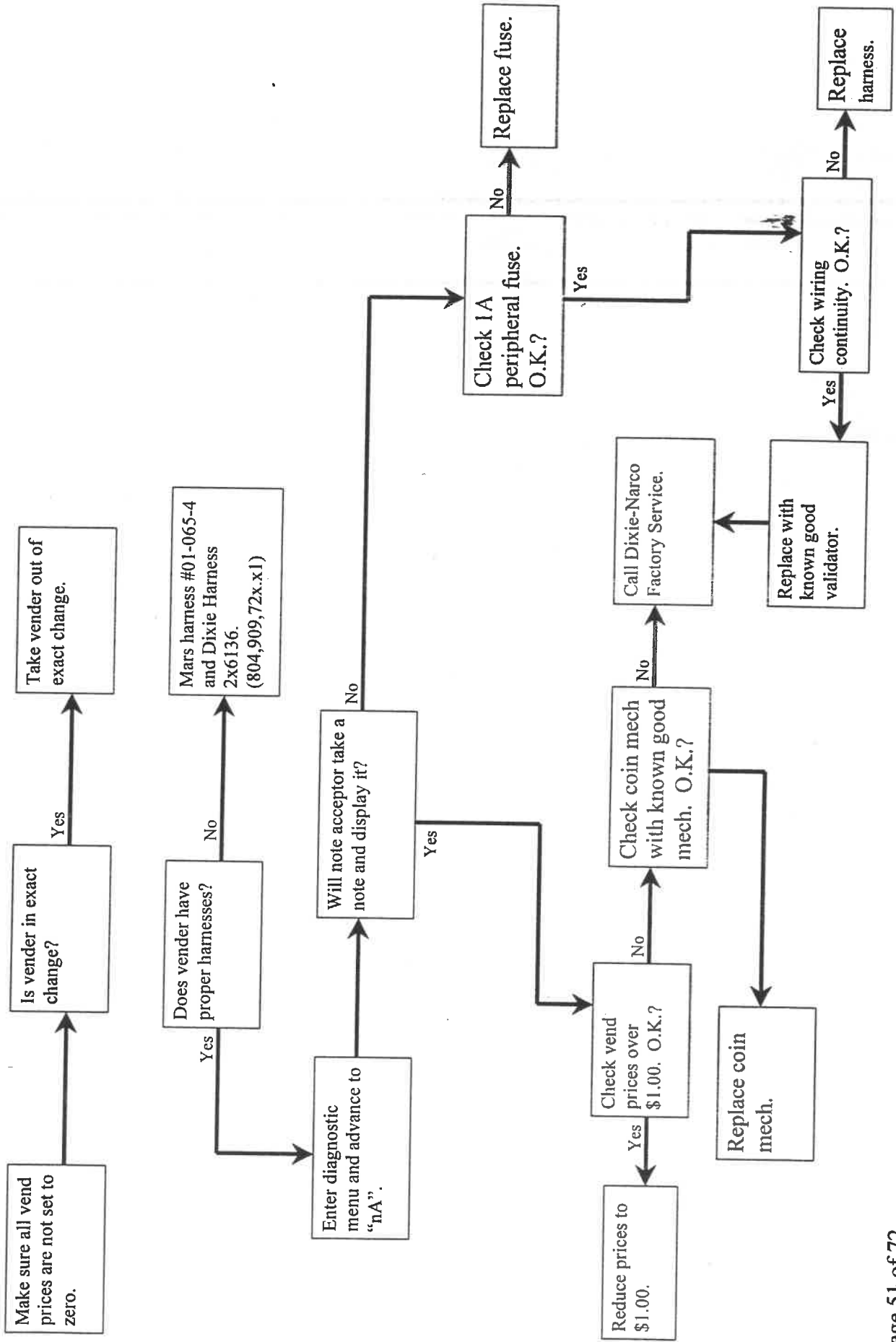

HIGH LEVEL NOTE ACCEPTOR TROUBLESHOOTING CHART (ALL ACCEPTORS)

Problem: Note Acceptor will not take note or display credit when it does take note.

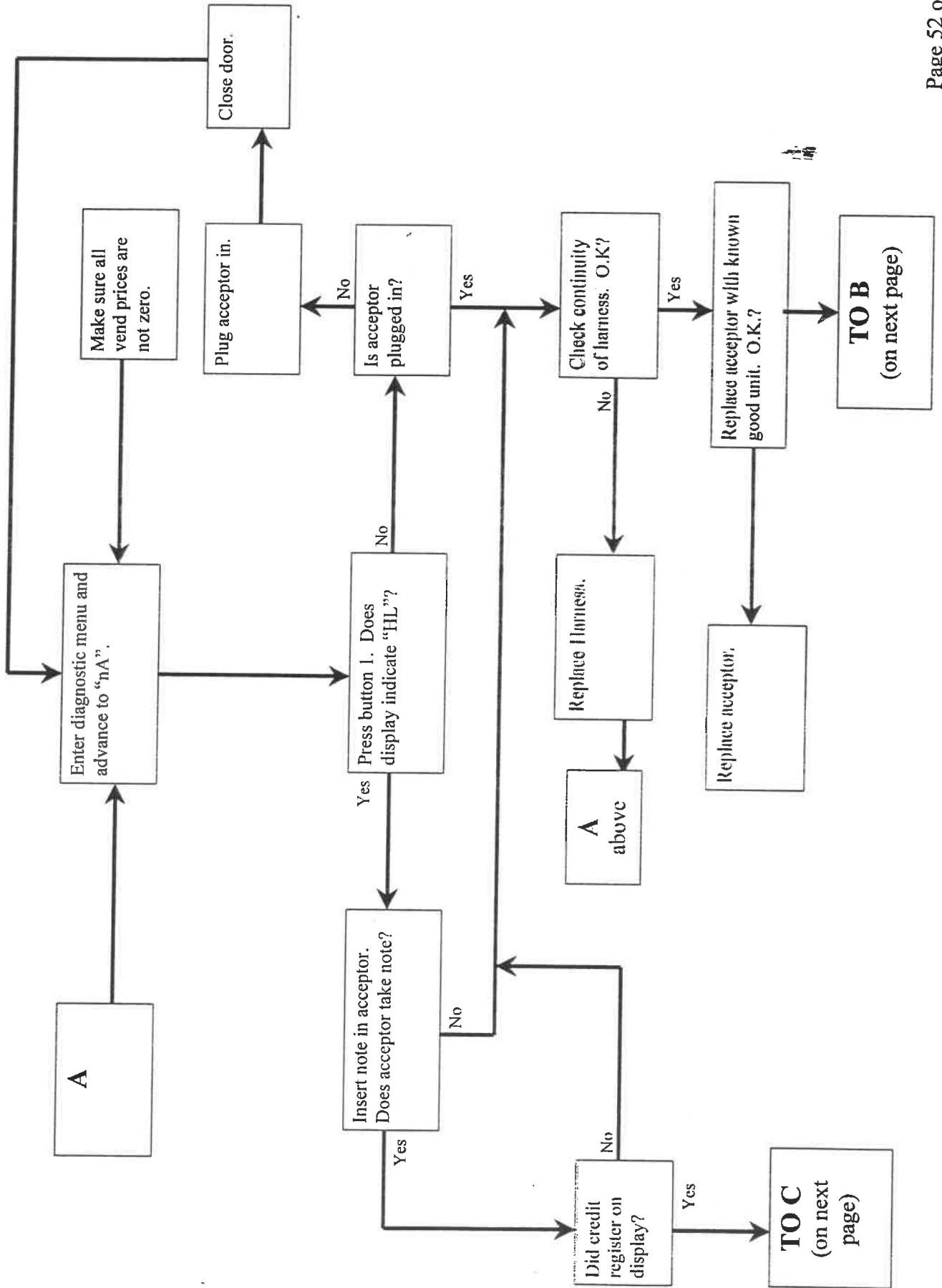

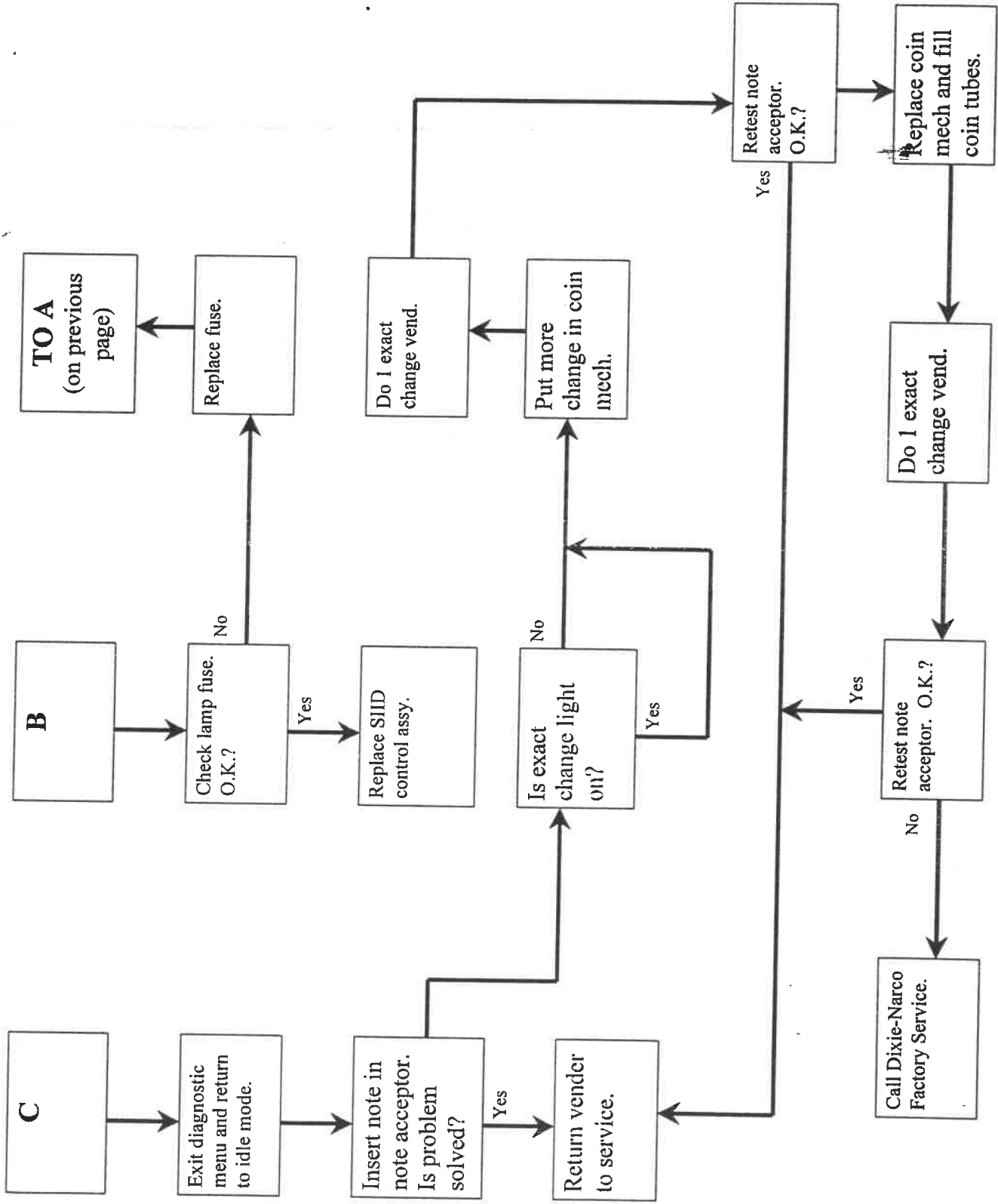

TROUBLESHOOTING CHART MULTIDROP COIN MECH / NOTE ACCEPTOR

Problem: Note acceptor will not accept notes, and the exact change light is off.

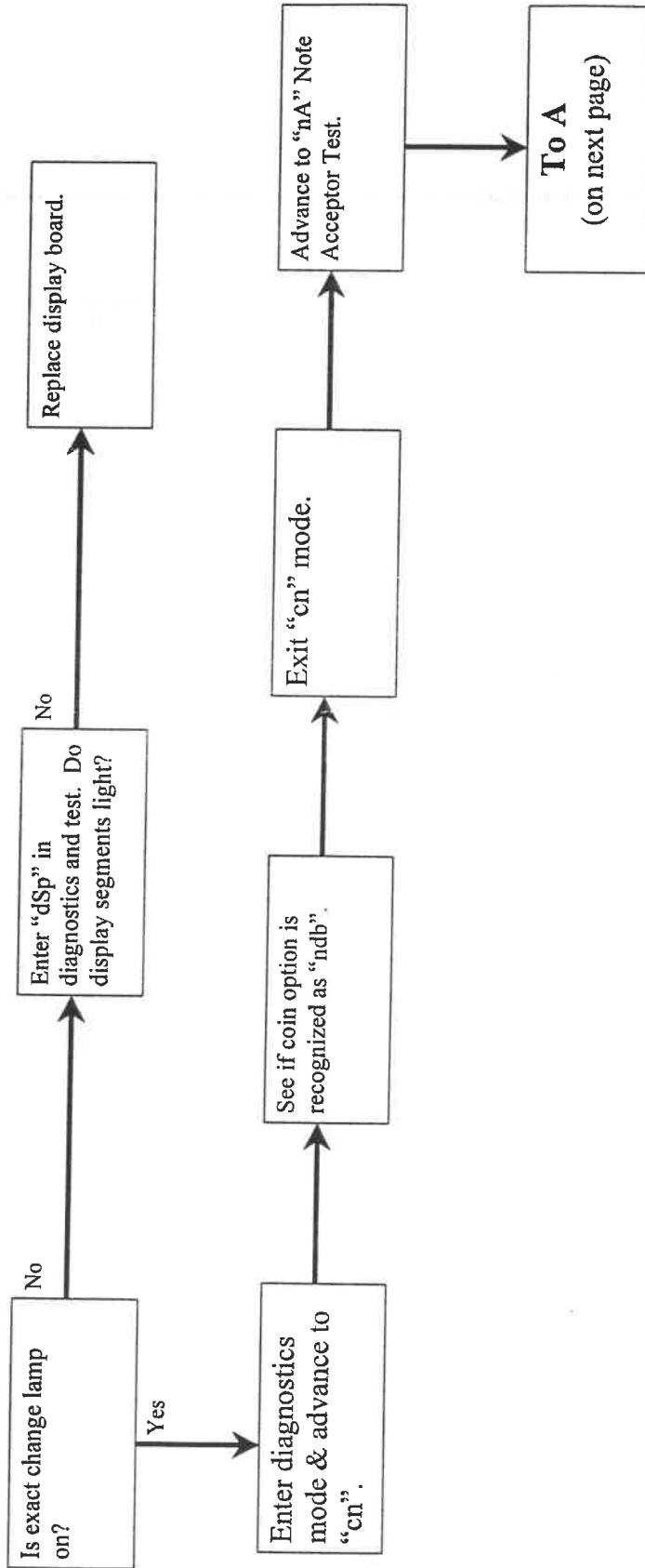

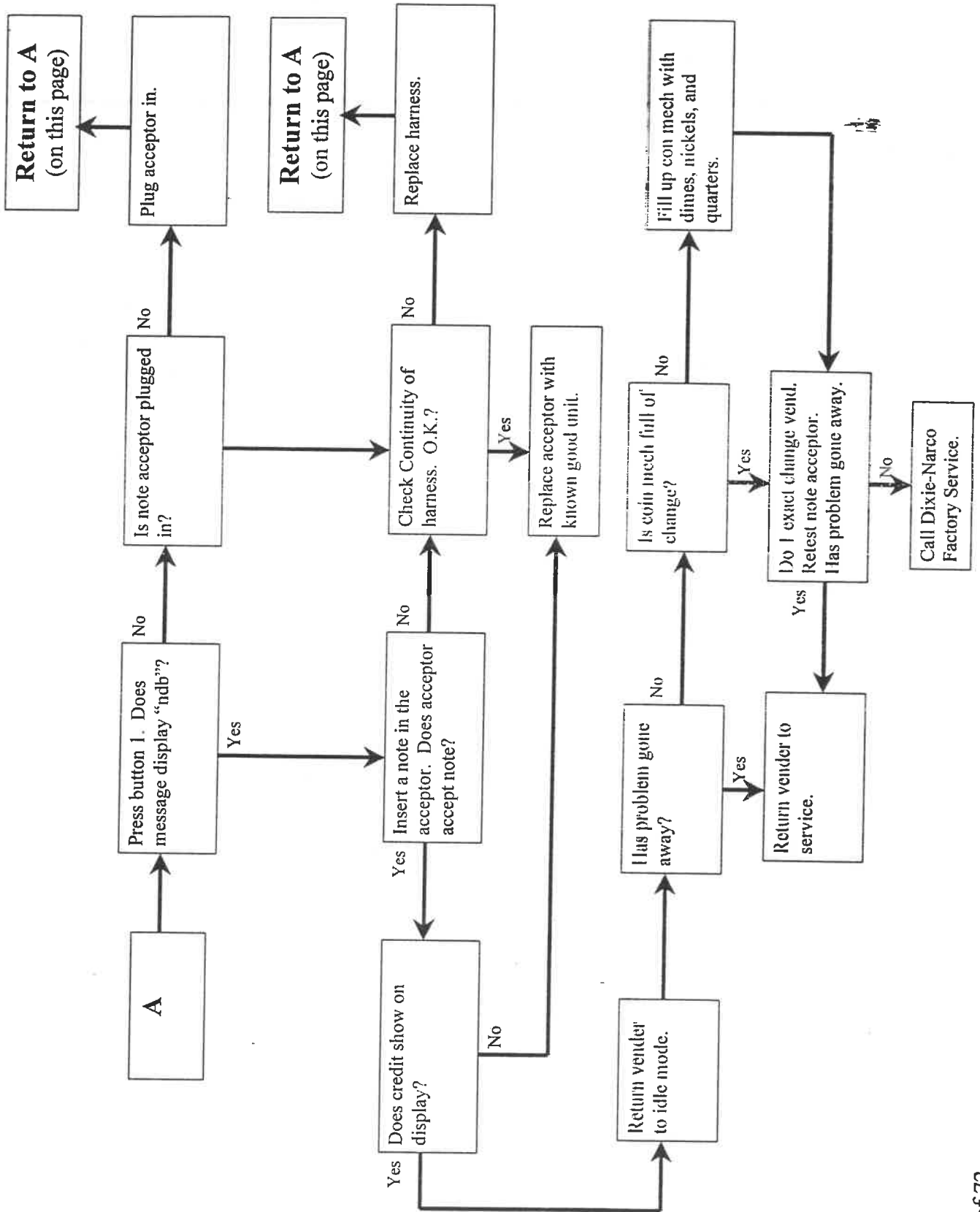

TROUBLESHOOTING CHART MULTIDROP COIN MECH

Problem: Mech will not accept coins

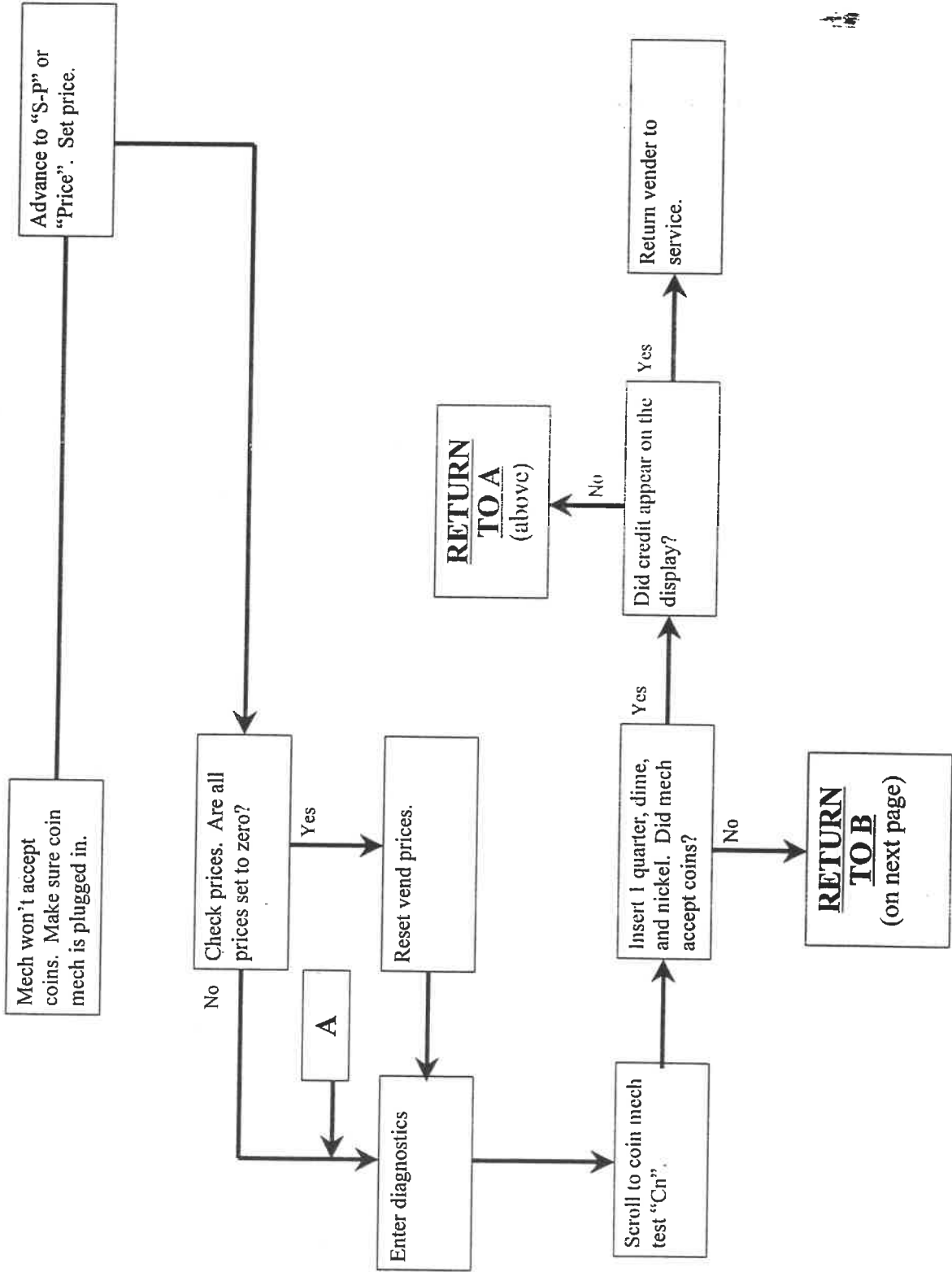

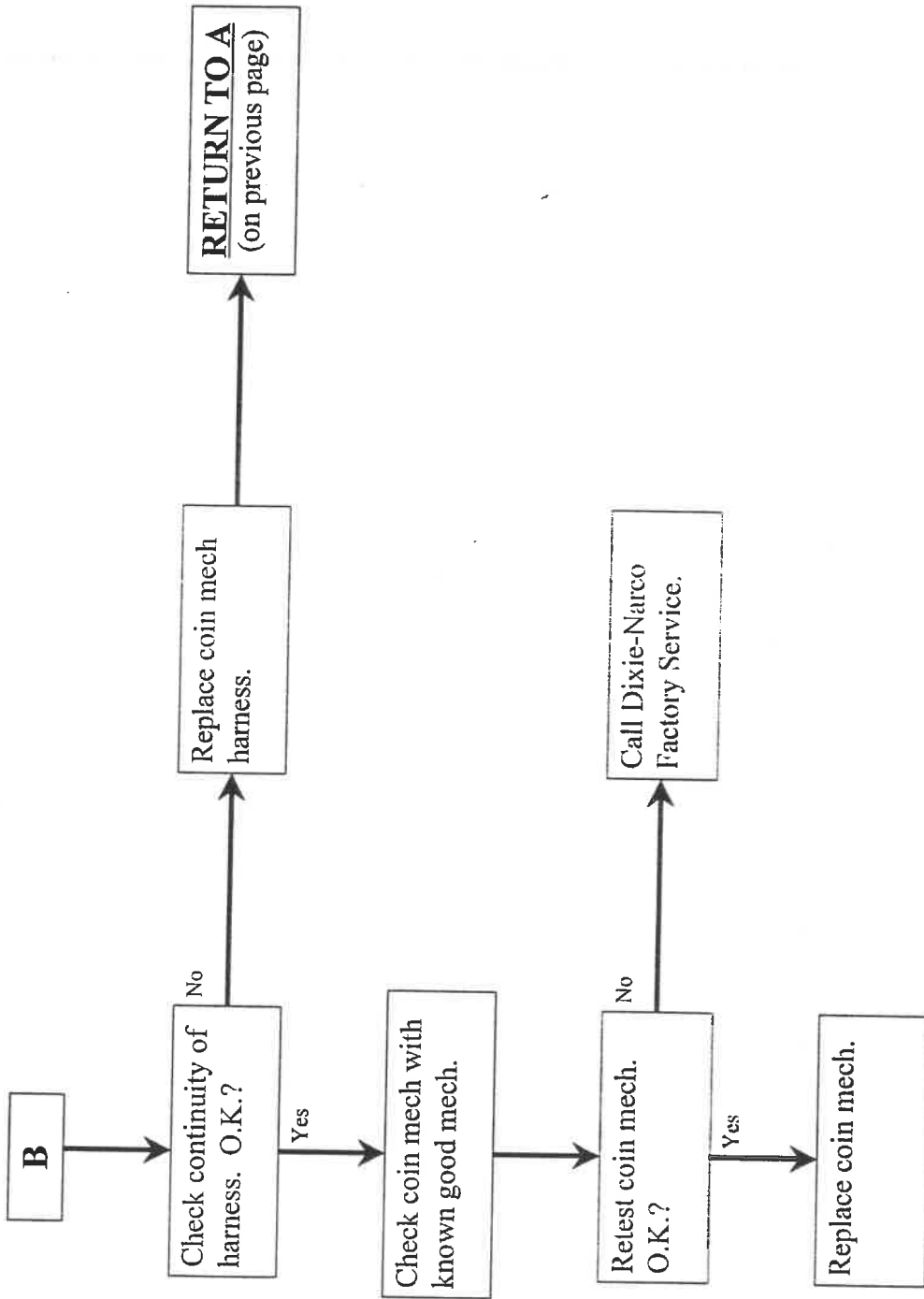

COIN MECH TROUBLESHOOTING FLOW CHART MC-5000 (MICRO MECHS)

All Coin Mechs

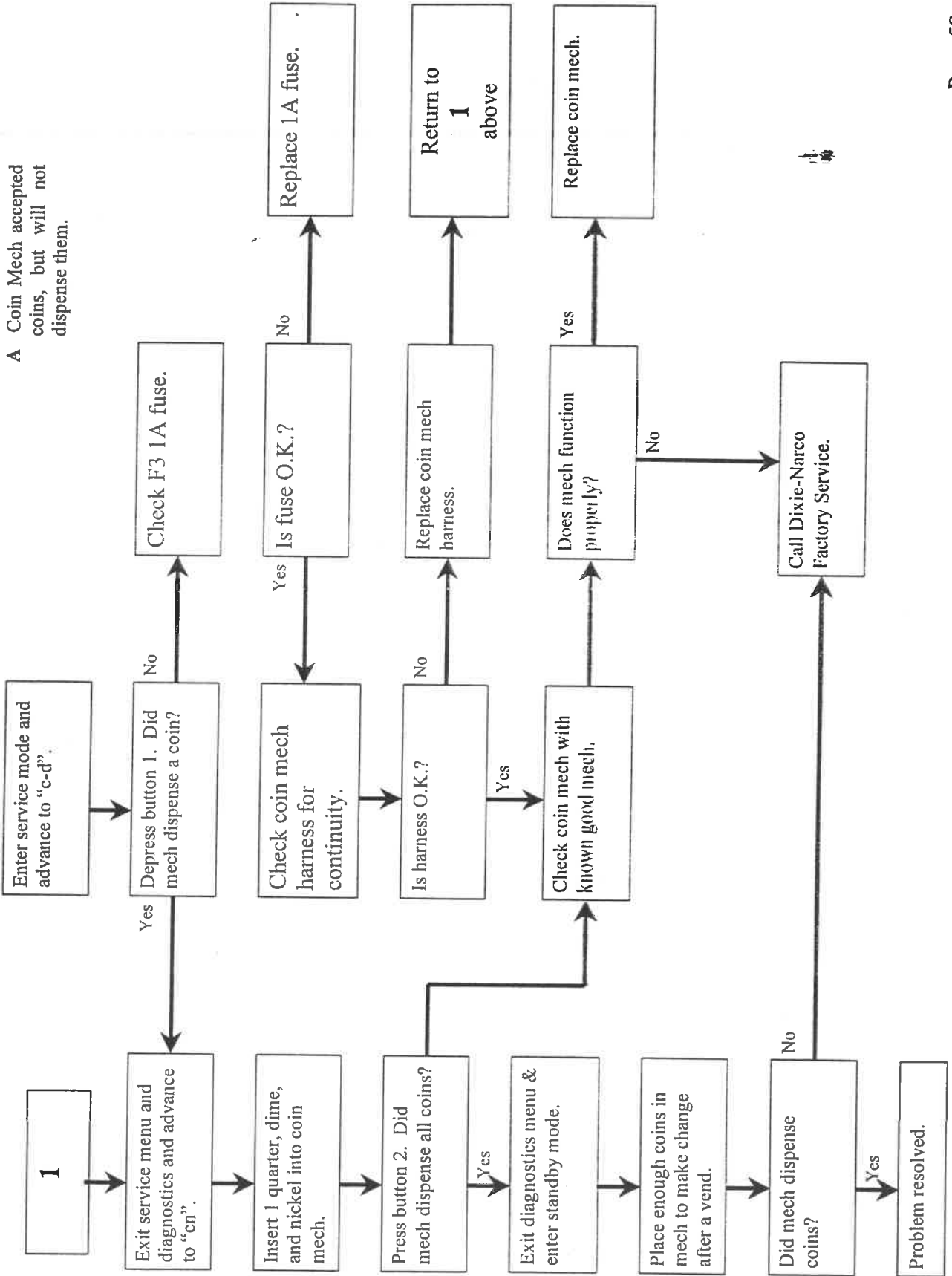

COIN MECH TROUBLESHOOTING CHART

L+/MC 5000 (Micro Mech) Interface Problems

A Not accepting money.
B Not displaying credit

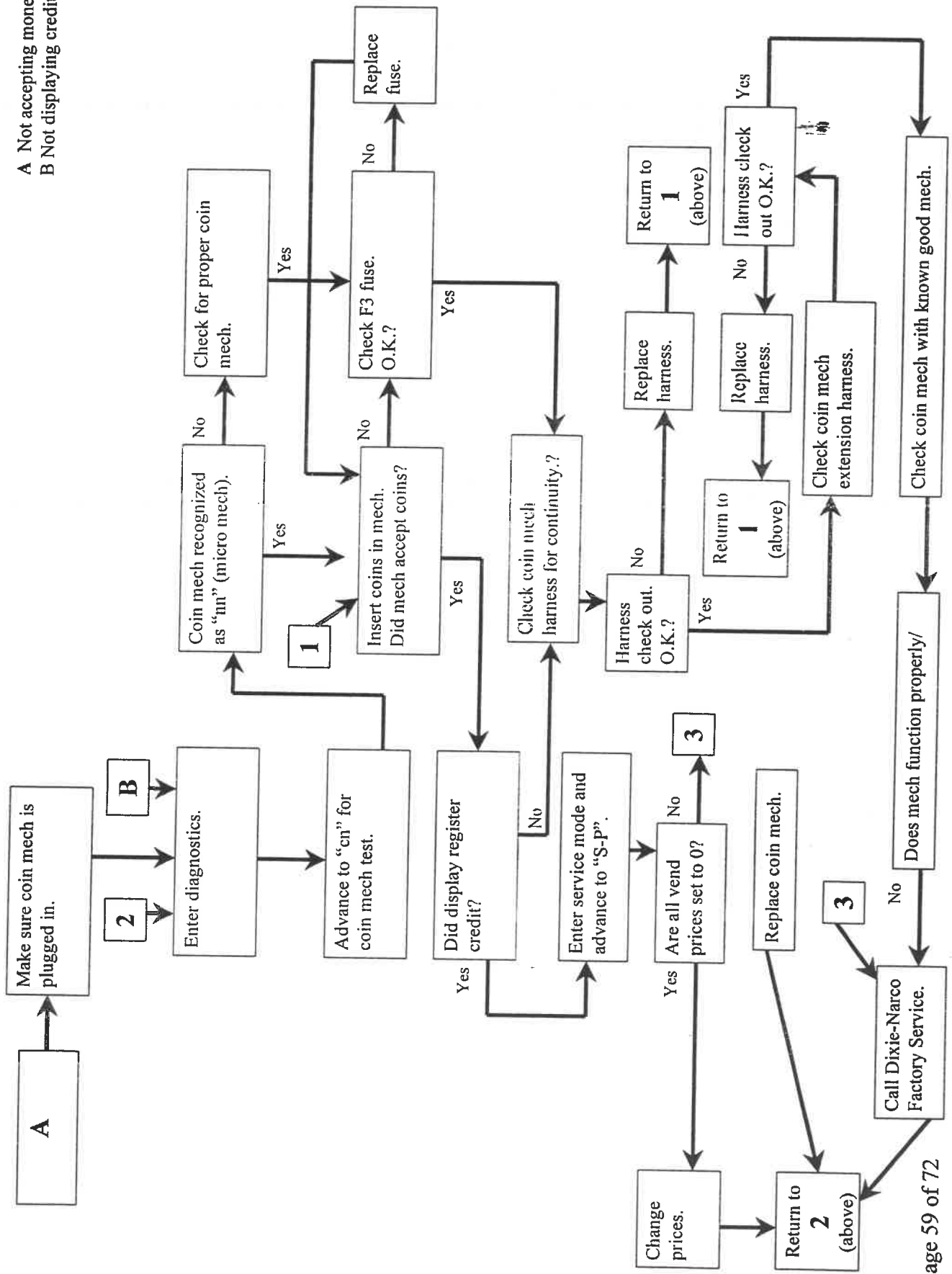

COIN MECH TROUBLESHOOTING CHART
MC-5000 (Micro Mech) Interface Maka Only
Problem: Mech will not accept coins.

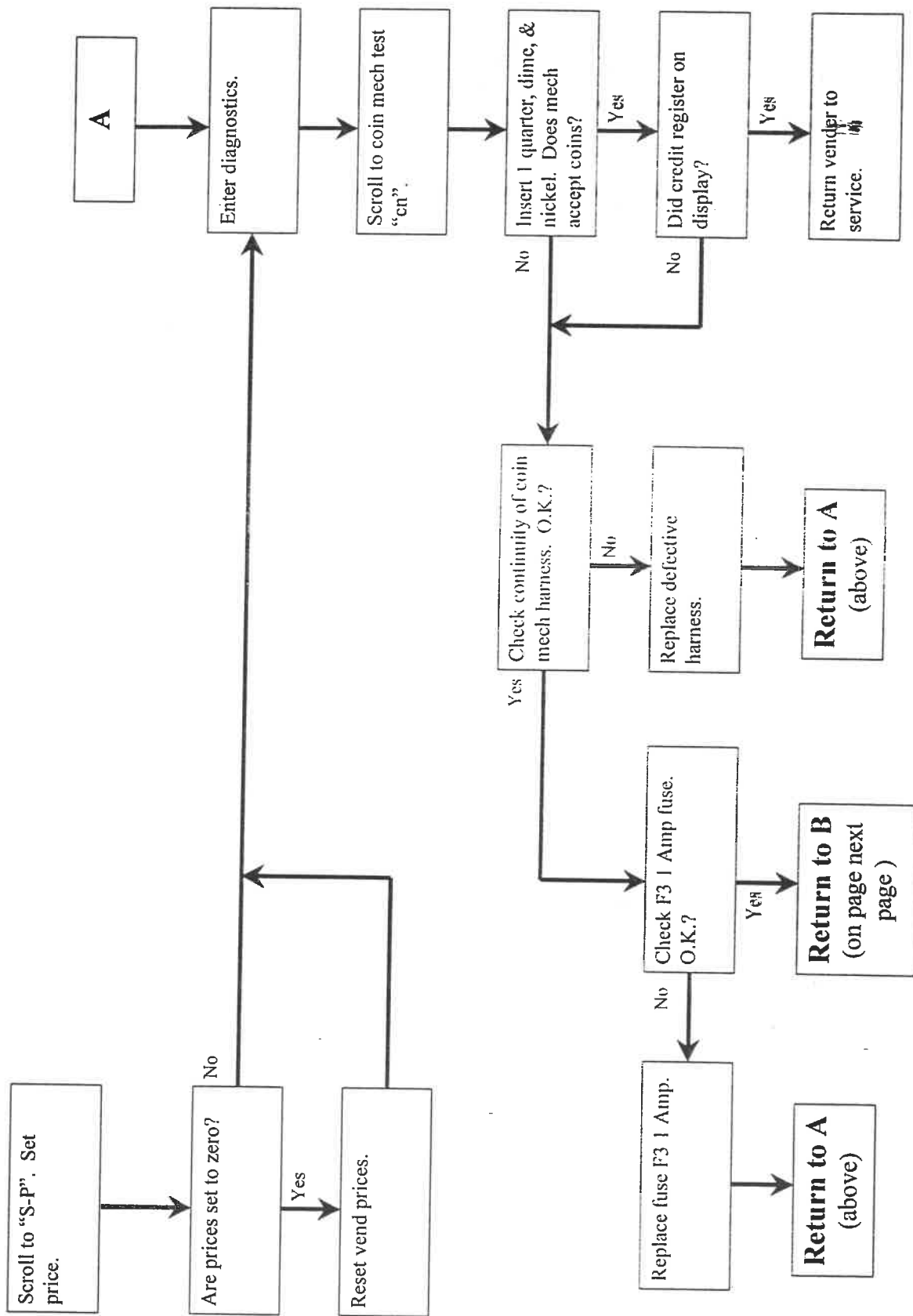

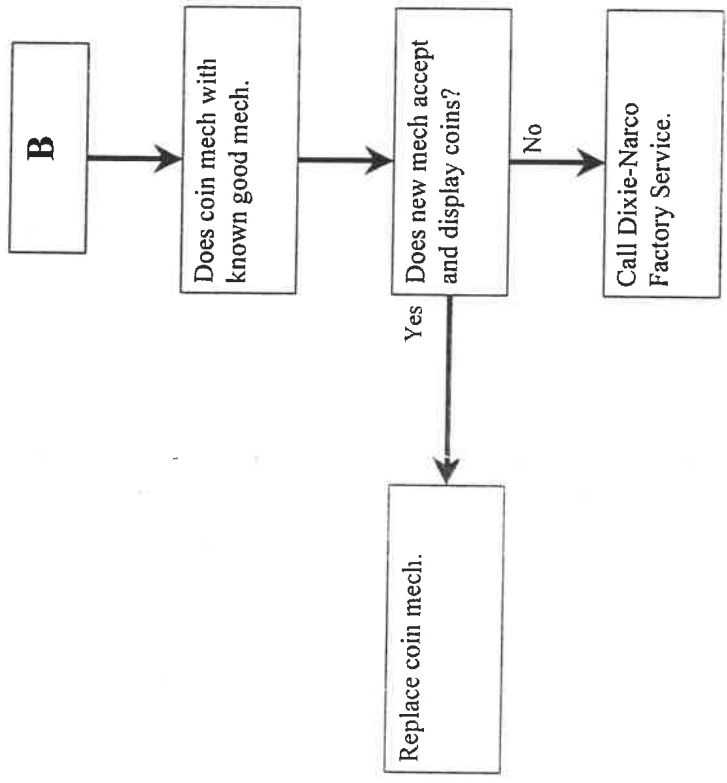

REFRIGERATION PARTS AND FUNCTIONS

MECHANICAL PARTS

COMPRESSOR MOTOR

The compressor motor (sealed in the compressor housing) drives the compressor with a shaft that is shared by both parts. It is started by the temperature control switch and the starting relay. It is stopped by the temperature control switch and if subject to overload by the thermal overload switch.

COMPRESSOR

The compressor (sealed in the compressor housing) draws cold, low pressure refrigerant from the evaporator and pumps hot, high pressure refrigerant gas out to the condenser.

CONDENSER

The condenser, located in the base of the vender, at the front, takes heat out of the hot, high pressure gas that comes from the compressor. The gas loses heat as it goes through the condenser coils, and changes into a liquid because it is still under pressure.

CONDENSER FAN

The condenser fan (between the condenser and the compressor motor) first draws air from the outside of the vender through the condenser. This air takes heat from the condenser first and then is blown over the compressor housing from which it also takes heat before going back outside of the vender. The condenser fan runs when the compressor motor runs.

FILTER/DRYER

The filter/dryer is in the liquid line between the condenser and the capillary tube. This dryer filters out any foreign particulate matter and also contains a desiccant to absorb any moisture that may be present in the system.

CAPILLARY TUBE

The capillary tube (between the condenser and the evaporator in the refrigerant line) has a very small inside diameter, and serves to control the refrigerant flow from the condenser into the evaporator.

EVAPORATOR

The evaporator (in the vender cabinet) takes heat from the air in the vender cabinet and gives this heat to the liquid refrigerant. The liquid refrigerant is evaporated (boiled off) as a gas, and the gas is drawn out by the compressor.

EVAPORATOR FAN

The evaporator fan draws warm air from around the cans or bottles in the cooling compartment and blows it across the evaporator. As the air goes across the evaporator, it gives up heat to the evaporator, then goes back to the cans or bottles, and takes heat from them. This fan runs continuously when the vender is plugged in.

CONDENSATE PAN

The condensate pan (located in the compressor compartment) collects the water which condenses on the evaporator. The water is evaporated into the surrounding air by means of soakers. The soakers extend down into the pan to absorb the water. Exposure to the surrounding air evaporates the water in the soakers.

ELECTRICAL PARTS

TEMPERATURE CONTROL

The temperature control is a temperature operated switch that controls power to the compressor and condenser fan motor in response to cabinet temperature. It consists of a capillary tube filled with a small amount of refrigerant connected to bellows and an electric switch. One end of the capillary tube is located in a slot in the evaporator housing. The other end is connected to the bellows and switch which are located in an enclosure in the lower right hand side of the cabinet. The pressure of the vapor in the capillary tube rises and falls with changes in the cabinet temperature. As the cabinet temperature gets warmer or cooler, the vapor expands or contracts, causing the bellows to operate, thereby the switch operates and turns the compressor on or off.

CAUTION: To adjust the temperature control see page 10.

THERMAL OVERLOAD ASSEMBLY

The thermal overload is a temperature activated switch that interrupts power to the compressor when excessive temperatures occur. This switch protects the compressor from the damage that will occur if the compressor continues to operate under adverse conditions. The overload also opens under abnormally high electrical current draw, protecting the motor windings from damage. Frequent overload trips may lead to warm product and be the first indication of a dirty condenser or other refrigeration related problems that require attention.

STARTING RELAY

The starting relay is a device that connects the start winding of the compressor during start up. The additional winding (start) helps the compressor motor come up to speed. Once it reaches speed the starting relay disconnects the start winding from the circuit.

ELECTRICAL OPERATION

WHAT DOES IT

WHAT HAPPENS

WHEN THE VENDER TEMPERATURE GETS UP TO THE CUT-IN SETTING:

The temperature control switch

Closes the run winding circuit of the compressor motor.

Closes the start relay coil circuit.

Closes in the condenser fan motor circuit.

THE HEAVY CURRENT, DRAWN BY THE RUN WINDING, ALSO FLOWS IN THE START RELAY COIL, AND:

The start relay coil

Closes the start relay contacts and completes the start winding circuit of the compressor motor.

WHEN THE COMPRESSOR MOTOR GETS UP TO SPEED

The spring in the relay

The start relay coil

Pushes the start relay contacts apart because no longer gets enough current to hold the contacts closed,

The start relay contacts

open in the start winding circuit of the compressor motor.

IF THE COMPRESSOR MOTOR DRAWS TOO MUCH CURRENT AND CAUSES THE THERMAL OVERLOAD ASSEMBLY TO GET TOO WARM

The thermal overload switch

Opens the run winding circuit and disconnects the compressor motor.

WHEN THE THERMAL OVERLOAD ASSEMBLY COOLS DOWN AGAIN

The thermal overload switch

Closes the run winding circuit and the start relay coil circuit of the compressor motor.

WHEN THE VENDER TEMPERATURE GETS DOWN TO THE CUT-OUT SETTING

The temperature control switch

Opens in the run winding circuit of compressor motor.

Opens in the starting relay coil circuit.

COMPRESSOR MOTOR RUN WINDING CIRCUIT

SWITCHES IN THE WIRING	WHAT THE SWITCHES DO	WHAT MAKES THE SWITCHES WORK
1. Temperature control switch	1. Turns the compressor and condenser fan motor on and off.	1. The temperature in the vender has come up to the cut-in point (or gotten down to the cut-out point) set on the temperature control switch.
2. Start Relay	2. Turns the start windings on & off.	2. The presence or absence of heavy current switches the relay which energizes or de-energizes the start windings.
3. Thermal Overload Switch	3. Protects the windings of the compressor.	3. Current drawn by the motor or heat from the compressor can raise the temperature of the thermal overload switch cut-out, which removes power from the compressor.

REFRIGERATION CIRCUIT DIAGRAMS

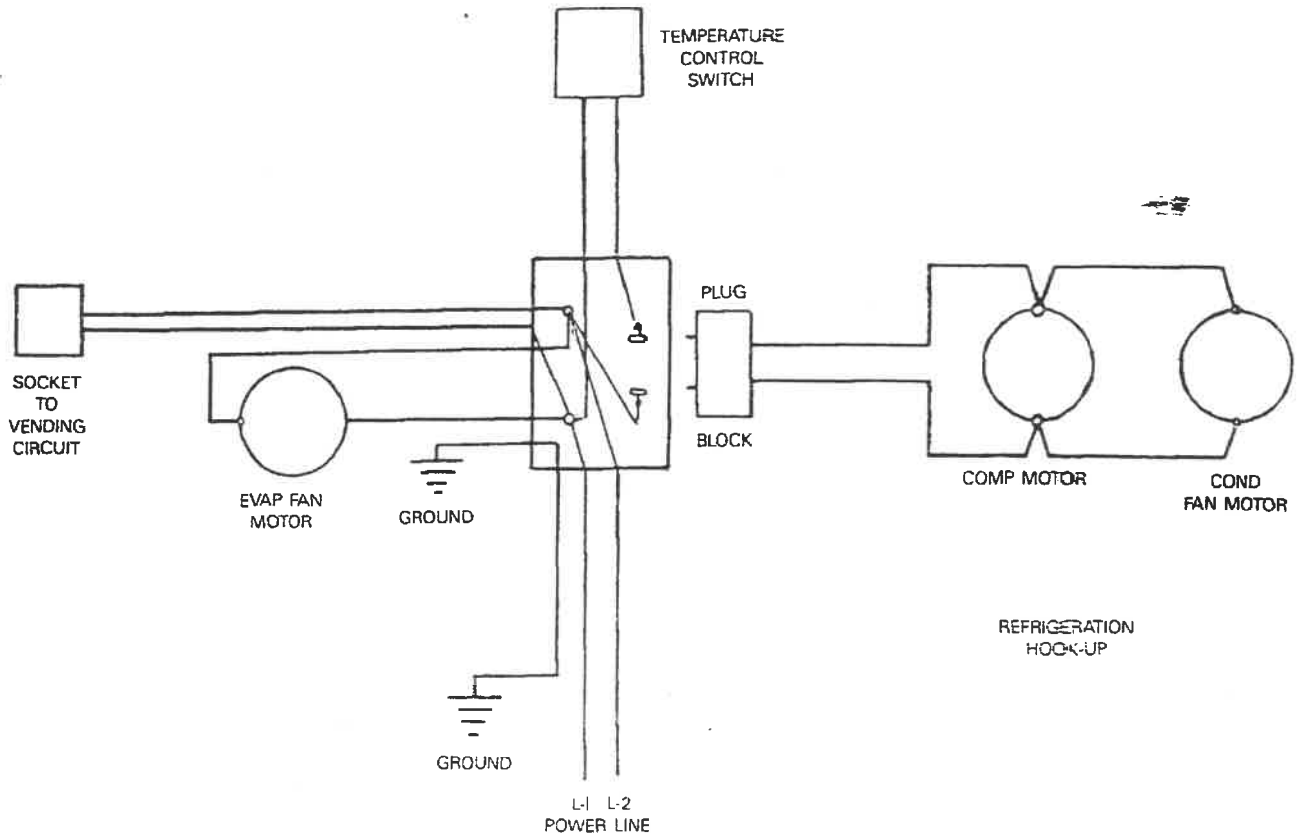

Tecumseh

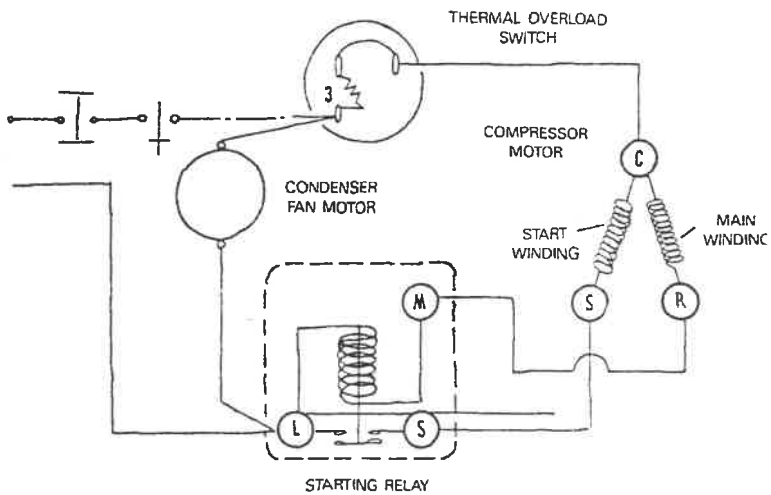

Embraco

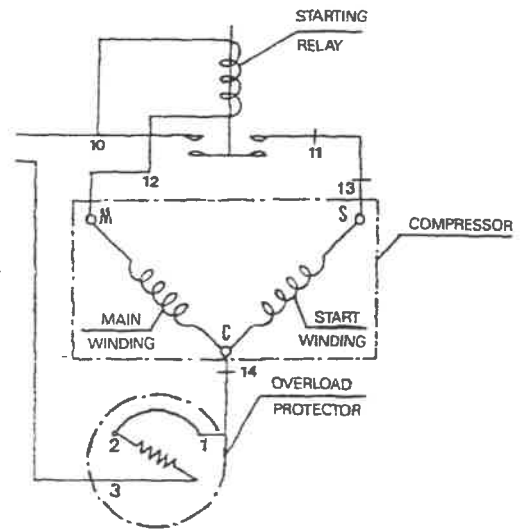

REFRIGERATION CYCLE

WHAT DOES IT	WHAT HAPPENS
The rising temperature in the vender	Warms the temperature control bulb & the charge in it.
The charge in the control bulb	Expands in the control tube and stretches the temperature control bellows.
The bellows	Activates the temperature control switch.
The temperature control switch	Turns the compressor motor on. Turns the condenser fan motor on.
The compressor motor	Drives the compressor.
The condenser fan motor	Drives the condenser fan. Draws air through the condenser, cooling it and pushes air over the compressor cooling it.
The compressor	Draws low pressure refrigerant gas from the evaporator. compresses the gas, and pumps it to the condenser.
The condenser	Takes the heat out of the high pressure refrigerant gas.
More hot gas coming from the compressor	Pushes the liquid refrigerant into the capillary tube.
The capillary tube	Controls the flow of liquid refrigerant into the evaporator.
The evaporator	(Where the pressure is kept low by the suction of the compressor) Transfers heat from the air to liquid refrigerant.
The liquid refrigerant	Changes into gas at low pressure and is drawn into the compressor.
The falling temperature in the vender	Cools the temperature control bulb and the charge in it to a pre-determined temperature.
The charge in the control bulb	Shrinks & lets the temperature control bellows pull back
The bellows	Move and open the temperature control switch.
The temperature control switch	Turns the compressor motor off. Turns the condenser fan motor off.
The compressor	Stops.
The condenser fan motor	Stops.
(With the vender "Plugged In" the evaporator fan motor runs constantly)	

SYMPTOM: PRODUCT HOT
Possible Cause: Compressor Will Not Run.

WHAT TO CHECK	SOLUTION
1. Is the vender plugged in? YES	1. NO , plug it in.
2. Is the compressor power cord plugged in? YES	2. NO , plug it in.
3. Is the temperature control on? YES	3. NO , turn it on.
4. Is there power at the wall outlet? YES	4. NO , consult an electrician.
5. Is the circuit breaker or fuse correct? YES	5. NO , replace or reset.
6. Is the vender power cord good? YES	6. NO , replace.
7. Is the compressor power cord good? YES	7. NO , replace.
8. Is the temperature control bulb located properly? YES	8. NO , correct.
9. Is the temperature control operational? YES	9. NO , replace.
10. Is the thermal overload operational? YES	10. NO , replace.
11. Is the start relay operational? YES	11. NO , replace.
12. Is the compressor operational? YES	12. NO , replace.
13. Consult the Dixie-Narco Factory Service at 1-800-688-9090.	

Note: Have the vender model and serial number available.

SYMPTOM: PRODUCT HOT

Possible Cause: Compressor Starts But Will Not Keep Running

WHAT TO CHECK	SOLUTION
1. Is the temperature control pointer set on its highest setting? YES	1. NO , adjust the pointer to a higher setting.
2. Domestically, is the voltage supply within +/- 10% of rating on serial plate? YES	2. NO , consult the power company.
3. Is the condenser clear of obstruction? YES	3. NO , clear or clean..
4. Is the condenser fan blade turning? YES	4. NO , free the obstruction or replace the blade if needed.
5. Is the condenser fan motor operational? YES	5. NO , replace.
6. Is the temperature control operational? YES	6. NO , replace
7. Is the tube from the compressor to the condenser free of kinks? YES	7. NO , repair or replace
8. Is the capillary tube free of kinks? YES	8. NO , replace.
9. Is the thermal overload operational? YES	9. NO , replace.
10. Is the start relay operational? YES	10. NO , replace.
11. Consult the Dixie-Narco Factory Service at 1-800-688-9090. Note: Have the vender model and serial number available.	

SYMPTOM: PRODUCT HOT

Possible Cause: Miscellaneous

WHAT TO CHECK	SOLUTION
1. Is the evaporator fan motor working? YES	1. NO , replace motor.
2. Has the refrigeration system lost its charge? NO	2. YES , replace the refrigeration system.
3. Consult the Dixie-Narco Factory Service at 1-800-688-9090. Note: Have the vender model and serial number available.	

SYMPTOM: PRODUCT COLD BUT NOT COLD ENOUGH

Possible Cause: Compressor Runs But Will Not Cool Product

WHAT TO CHECK	SOLUTION
1. Is the temperature control pointer set properly? YES	1. NO , adjust to desired setting.
2. Domestically, is the voltage supply between 103V and 127V? YES	2. NO , call the power company.
3. Is the temperature control probe located properly? YES	3. NO , correct its position.
4. Is the condenser clear of obstruction? YES	4. NO , clear, clean, or space the vender.
5. Is the evaporator fan free of obstruction? YES	5. NO , free any obstruction or replace.
6. Is the condenser fan free of obstruction? YES	6. NO , free any obstruction or replace.
7. Is the evaporator free of ice? YES	7. NO , defrost and check the following: gasket seal, port door seal, refrigerant charge.
8. Is the temperature control operational? YES	8. NO , replace.
9. Is the evaporator fan operational? YES	9. NO , replace.
10. Is the condenser fan motor operational? YES	10. NO , replace.
11. Is the refrigerant tubing free of kinks? YES	11. NO , repair or replace.
12. Is the overload operational? YES	12. NO , replace.
13. Is the start relay operational? YES	13. NO , replace.
14. Is there refrigerant in the system? YES	14. NO , charge system and check for leaks.
15. Consult the Dixie-Narco Factory Service at 1-800-688-9090.	

Note: Have the vender model and serial number available.

SYMPTOM: PRODUCT TOO COLD OR FROZEN

Possible Cause: Compressor Runs Too Long or Continuously

WHAT TO CHECK	SOLUTION
1. Is the temperature control the correct one for the equipment being used? YES	1. NO, install correct control.
2. Is the temperature control pointer set properly? YES	2. NO, set properly.
3. Is the temperature control bulb located properly. YES	3. NO, correct.
4. Is the temperature control operational? YES	4. NO, replace.
5. Does the evaporator frost over completely while the system is running? YES	5. NO, check for leaks or a low charge.
6. Consult the Dixie-Narco Factory Service at 1-800-688-9090. Note: Have the vender model and serial number available.	

SYMPTOM: NOISY REFRIGERATION UNIT

WHAT TO CHECK	SOLUTION
1. Are the refrigerant lines free of contact with surfaces? YES	1. NO, reposition tubing.
2. Is the condenser fan blade obstructed or damaged? NO	2. YES, free any obstructions or replace the blade if need..
3. Is the evaporator fan blade obstructed or damaged? NO	3. YES, free any obstructions or replace the blade if needed.
4. Is the compressor noisy? NO	4. YES, replace.
5. Consult the Dixie-Narco Factory Service at 1-800-688-9090. Note: Have the vender model and serial number available.	

SYMPTOM: EXCESSIVE CONDENSATE

WHAT TO CHECK	SOLUTION
<p>1. Is the door sealed properly? (This can be checked by inserting a piece of paper, thin plastic, or paper currency between the cabinet and the door seal when the main door is open. When the door is closed properly the paper should exert some resistance as it is pulled out.) YES, go to step 4.</p>	<p>1. NO, Ensure the door is closed tightly. If door still does not seal properly, see step 2.</p>
<p>2. Is the motor cover interfering with the inner door? NO, go to step 3.</p>	<p>2. YES, reinstall the motor cover properly.</p>
<p>3. Has the machine been vandalized? NO, go to step 4.</p>	<p>3. YES, replace necessary components.</p>
<p>4. Are the drain pan soakers positioned properly? YES</p>	<p>4. NO, place soakers upright in pan so that air will flow over and through the soakers..</p>
<p>5. Is the drain hose positioned properly? YES</p>	<p>5. NO, place the drain hose in the drain pan along side of the soakers. Ensure the drain hose is not clogged.</p>
<p>6. Are there fourteen fiberglass soakers in the pan? YES</p>	<p>6. NO, place fourteen fiberglass soakers in the condensate pan.</p>
<p>7. Are the condensate & evaporator free from obstruction? YES</p>	<p>7. NO, remove all debris and/or cans from the area around the evaporator and condenser. Clean the evaporator and condenser coils with a stiff brush or compressed air.</p>
<p>8. Is the delivery door misaligned? NO</p>	<p>8. YES, A. Level the vender properly. B. Align the inner and outer doors so that the delivery door does not stick open.</p>
<p>9. Consult the Dixie-Narco Factory Service at 1-800-688-9090. Note: Have the vender model and serial number available.</p>	<p>9. Consult the Dixie-Narco Factory Service at 1-800-688-9090. Note: Have the vender model and serial number available.</p>